

3 May 2018

Global Registry

Created on 18 November 2004, pursuant to Article 6 of the Agreement concerning the establishing of global technical regulations for wheeled vehicles, equipment and parts which can be fitted and/or be used on wheeled vehicles (ECE/TRANS/132 and Corr.1) done at Geneva on 25 June 1998

Addendum 20: Global Technical Regulation No. 20

Global Technical Regulation on the Electric Vehicle Safety (EVS)

Established in the Global Registry on 14 March 2018



UNITED NATIONS

GE.18-07039(E)



* 1 8 0 7 0 3 9 *

Please recycle 



Global Technical Regulation on Electric Vehicle Safety (EVS)

Contents

	<i>Page</i>
I. Statement of technical rationale and justification.....	7
A. Introduction	7
B. Procedural background	7
C. Technical background.....	8
D. Principle for developing the global technical regulation.	14
E. Technical rationale and justification	16
F. Recommendations.....	57
G. Existing regulations, directives, and international voluntary standards	58
H. Benefits and costs	61
II. Text of regulation	63
1. Purpose	63
2. Scope	63
3. Definitions	64
4. General requirements	67
5. Performance requirements	68
5.1. Requirements of a vehicle with regard to its electrical safety - in-use	68
5.1.1. Protection against electric shock.....	68
5.1.2. Functional safety.....	71
5.2. Requirements of a vehicle with regard to its electrical safety - post-crash.....	72
5.2.1. General principle	72
5.2.2. Protection against electric shock.....	72
5.3. Requirements with regard to installation and functionality of rechargeable electrical energy storage system (REESS) in a vehicle	74
5.3.1. Installation of REESS on a vehicle.....	74
5.3.2. Warning in the event of operational failure of vehicle controls that manage REESS safe operation.....	74
5.3.3. Warning in the case of a thermal event within the REESS	74
5.3.4. Warning in the event of low energy content of REESS	75
5.4. Requirements with regard to the safety of REESS - in-use	75
5.4.1. General principle.	75
5.4.2. Vibration.....	75
5.4.3. Thermal shock and cycling	76
5.4.4. Fire resistance	76

5.4.5.	External short circuit protection	76
5.4.6.	Overcharge protection	76
5.4.7.	Over-discharge protection.....	77
5.4.8.	Over-temperature protection.....	77
5.4.9.	Overcurrent protection.....	77
5.4.10.	Low-temperature protection	78
5.4.11.	Management of gases emitted from REESS	78
5.4.12.	Thermal propagation.....	78
5.5.	Requirements with regard to the safety of REESS - post-crash	80
5.5.1.	Vehicle based test	80
5.5.2.	REESS-component based test.....	81
6.	Test procedures	82
6.1.	Test procedures for electrical safety	82
6.1.1.	Isolation resistance measurement method	82
6.1.2.	Confirmation method for functions of on-board isolation resistance monitoring system	86
6.1.3.	Protection against direct contact to live parts	87
6.1.4.	Test method for measuring electric resistance	89
6.1.5.	Test procedure for Protection against water effects.....	90
6.1.6.	Test conditions and test procedure regarding post-crash	90
6.2.	Test procedures for REESS	94
6.2.1.	General procedures	94
6.2.2.	Vibration test	95
6.2.3.	Thermal shock and cycling test	97
6.2.4.	Fire resistance test.....	98
6.2.5.	External short circuit protection	102
6.2.6.	Overcharge protection test.....	103
6.2.7.	Over-discharge protection test.....	106
6.2.8.	Over-temperature protection test	109
6.2.9.	Overcurrent protection test	111
6.2.10.	Mechanical shock test.....	112
6.2.11.	Mechanical integrity test.....	114
7.	Heavy duty vehicles – Performance requirements.....	116
7.1.	Requirements of a vehicle with regard to its electrical safety - in-use	116
7.1.1.	Protection against electric shock.....	116
7.1.2.	Functional safety.....	120

7.2.	Requirements with regard to installation and functionality of REESS in a vehicle...	120
7.2.1.	Installation of REESS on a vehicle.....	120
7.2.2.	Warning in the event of operational failure of vehicle controls that manage REESS safe operation	121
7.2.3.	Warning in the case of a thermal event within the REESS	121
7.2.4.	Warning in the event of low energy content of REESS	122
7.3.	Requirements with regard to the safety of REESS - in-use	122
7.3.1	General principle	122
7.3.2.	Vibration.....	122
7.3.3.	Thermal shock and cycling	122
7.3.4.	Fire resistance	123
7.3.5.	External short circuit protection	123
7.3.6.	Overcharge protection	123
7.3.7.	Over-discharge protection.....	123
7.3.8.	Over-temperature protection.....	124
7.3.9.	Reserved	124
7.3.10.	Low-temperature protection	124
7.3.11.	Management of gases emitted from REESS	124
7.3.12.	Thermal propagation.....	125
7.4.	Requirements with regard to the safety of REESS simulating inertial load	126
7.4.1.	Mechanical shock	126
8.	Heavy duty vehicles - Test procedures	127
8.1.	Test procedures for electrical safety	127
8.1.1.	Isolation resistance measurement method	127
8.1.2.	Confirmation method for functions of on-board isolation resistance monitoring system	130
8.1.3.	Protection against direct contact to live parts	131
8.1.4.	Test method for measuring electric resistance	133
8.1.5.	Test procedure for Protection against water effects.....	134
8.2.	Test procedures for REESS	135
8.2.1.	General procedures	135
8.2.2.	Vibration test	136
8.2.3.	Thermal shock and cycling test	137
8.2.4.	Fire resistance test.....	138
8.2.5.	External short circuit protection	142
8.2.6.	Overcharge protection test	144

8.2.7.	Over-discharge protection test	146
8.2.8.	Over-temperature protection test	149
8.2.9.	Reserved	151
8.2.10.	Mechanical shock test.....	151

Annexes

1	Determination of hydrogen emissions during the charge procedures of the REESS.....	154
	Appendix 1: Calibration of equipment for hydrogen emission testing.....	165
2	Verification method for testing authorities confirming document based isolation resistance compliance of electrical design of the vehicle after water exposure	168

I. Statement of technical rationale and justification

A. Introduction

1. Electromobility represents the concept of using electric powertrain technologies with a view to address climate change, improve air quality and reduce fossil fuel dependency. The current regulatory pressure to lower CO₂ and pollutant emissions is helping to drive an increasing market penetration of vehicles utilizing electric powertrain (hereafter, "electrically propelled vehicles" or "EV"). Furthermore, many governments support the development and deployment of EV by financing research or offering incentives for consumers. Consequently, the automotive industry is investing in research and development, as well as the production capacity for electric vehicles, at a scale not seen in the past.

2. Together with support measures for industry development, many governments have already started to define their regulatory framework for EV, mostly in order to ensure their safety and thus gain consumer confidence, but also in consideration of environmental performance measures.

3. Because of the relatively small volume of EV and their components currently produced, any degree of convergence between regulatory obligations can result in economies of scale and cost reductions for automotive manufacturers – critical in the context of economic recovery and the general cost-sensitiveness of the industry.

4. This United Nations Global Technical Regulation (UN GTR) introduces performance-oriented requirements that address potential safety risks of EVs while in use and after a crash event, including electrical shocks associated with the high voltage circuits of EVs and potential hazards associated with lithium-ion batteries and/or other Rechargeable Electrical Energy Storage Systems (REESS) (in particular, containing flammable electrolyte).

5. UN GTR requirements are based on the best available data, scientific research and analysis and reflect the outcome of technical discussions between the experts representing the industry, testing authorities and the Governments of Canada, China, European Union, Japan, Republic of Korea and the United States of America.

B. Procedural background

6. The Executive Committee of the 1998 Agreement (AC.3) gave, in November 2011, its general support to a joint proposal by the United States of America, Japan and the European Union to establish two working groups to address the safety and environmental issues associated with EVs. That proposal (ECE/TRANS/WP.29/2012/36. and Corr.1) was submitted to the World Forum for Harmonization of Vehicle Regulations (WP.29) at its March 2012 session for further consideration and formal adoption. AC.3 has adopted this proposal with China as one of the co-sponsors together with Japan, United States and European Union.

7. The objective of the two working groups is to seek regulatory convergence on the global scale via the work in the framework of the 1998 Agreement. Then, the Terms of Reference (TOR) for the electric vehicle safety (EVS) working group with the goal of establishing a UN GTR for EVs covering high voltage electrical safety, safety of electrical components, and REESS (ECE/TRANS/WP.29/2012/121) had been adopted at the one-hundred-and-fifty-eighth session of WP.29 in March 2012.

8. The aim of this working group is to sponsor an effort to develop one UN GTR (or more, if appropriate) to address the safety of EVs.
9. Other topics that the EVS informal working group could consider, insofar as these topics may be relevant for the technical requirements to be developed, are:
 - (a) The different standards for electro-mobility (vehicle inlets for charging);
 - (b) Best practices or guidelines for manufacturers and/or emergency first responders.
10. Given the complexity of issues discussed, the informal working group requested extension of the mandate twice, in November 2014 (ECE/TRANS/WP.29/2014/87) and November 2015 (ECE/TRANS/WP.29/2016/30), each time by one year.
11. To resolve particular technical issues in an efficient manner, nine task force groups have been set up and met nine times between October 2014 and September 2016. Task force groups successfully addressed a large number of safety related issues according to the given mandate, however, more discussion is required on some critical issues, where research and testing of methods are still in progress.
12. Under such circumstances, the informal working group agreed that the most appropriate way to establish the UN GTR within the given mandate was to address the agreed safety issue in Phase 1 while leaving those safety requirements that require long-term research and verification for Phase 2, which is expected to start as soon as possible.

C. Technical background

13. This section provides additional information on a number of technical discussions and decisions taken by the informal working group and its Task Forces. The following items are considered important for further development of UN GTR.

1. Venting/management of gases

14. Quantification of venting for tests addressing safety of REESS post-crash:

At the moment, venting is not adopted as a requirement for tests addressing safety of REESS post-crash. Assessment of potential safety risks of this requires more research to evaluate whether limits for emissions are required, for which species and which technique can be used to measure these. It was not possible to research and analyse this in Phase 1. Therefore, it will be considered in Phase 2 of this Regulation.

15. Potential risk of "toxic gases" from non-aqueous electrolyte:

During the informal working group discussion, and based on analysis and data provided by European Commission's Joint Research Centre (JRC), a potential risk related to the release and evaporation of non-aqueous electrolyte and the potential formation of a toxic atmosphere was discussed (EVSTF-04-13e, EVS-07-24e).¹ As of now, and although the topic is mentioned in various standards: UL 2580, SAE J2464, SAE J2289, SAE J2990, ISO 6469, some of which even recommend gas/analytical detection techniques, there is no clear measurement procedure suitable for all scenarios (component/vehicle level, in-use/post-crash). Even with consideration of the huge amount of electric and hybrid vehicles that are already on the street in Asia, Europe and North America incidents of evaporation

¹ N.P. Lebedeva, L. Boon-Brett, "Considerations on the chemical toxicity of contemporary Li-ion battery electrolytes and their components", J Electrochem Soc, 2016, 163, A821-A830.

especially during in use are not documented as of today. Nevertheless, more field or research data is required to define an analytical technique suitable for detecting evaporated species from leaked electrolyte. Based on the outcome of this research, modifications to the requirements and methods with respect to leakage and evaporation of non-aqueous electrolyte may be necessary in the future.

2. Warning signals

16. In relation to a requirement of a warning signal to the driver in the event of a failure of the REESS, the informal working group was tasked with not only identifying safety scenarios associated with REESS that require a warning, but also with the development of requirements and test procedures that would test whether the warning operates under the identified REESS related safety scenarios.

17. Three safety scenarios associated with REESS were identified where a warning to the driver would be required. The first is operational failure of one or more aspects of vehicle control(s) that manage the safe operation of the REESS. The second is when a significant thermal event occurs internal to the REESS and the third is when the REESS is at a low energy state. Details on the rationale for the selection of these three safety scenarios are presented in section E.

18. A survey of electrically propelled vehicles was conducted for developing test procedures to evaluate the operation of the warning under specific safety scenarios. The survey indicated that these test procedures would vary depending on electric vehicle architectures and vehicle manufacturers. Therefore developing a single test procedure would not be practicable and may be design restrictive. Consequently, manufacturers would be required to submit, upon request, technical documentation describing the functionality of the system triggering the warning for a given vehicle.

19. An attempt was made to develop specifications for the type of warning. However, due to regional differences in how public perceives warnings and due to differences in vehicle operation and designs, consensus could not be developed on the colour, style, symbol, or text of the warning. Therefore, the characteristics of the warning are not specified in this UN GTR.

20. This UN GTR does not specify detail characteristics of the warning in the form of test requirements evaluating the warning function. Instead, the proposal of this UN GTR requires manufacturers to provide relevant information specific to the vehicle about the method of triggering driver warning and a description of the warning tell-tale.

3. Thermal propagation

21. The thermal propagation test procedure is currently not adopted as a requirement. Canada, China, EU, Japan, Republic of Korea, United States of America and Organization of Motor Vehicle Manufacturers (OICA) have made a significant contribution to this work and ISO/TC22/SC37/WG3 is also considering thermal propagation tests. The reports and presentations of stakeholders are available at UNECE Website.² However, the group agreed that further research is needed which builds on work/results of this working group. Several stakeholders have expressed their commitment to the task of developing the thermal propagation method to advance the work performed in Phase 1. Research will be performed with this objective, whose scope will be to improve the identified shortcomings of the test methods developed by different Contracting Parties to the 1998 Agreement (1998 Ag. C.Ps.) in Phase 1 and which can include:

² <https://www2.unece.org/wiki/display/trans/EVS+13th+session+-Annex-Thermal+propagation+test>

- (a) Further investigation of previously considered initiation methods to evaluate proposed initiation methods and their feasibility, repeatability and reproducibility;
- (b) Investigate potential new methods for initiation including methods which minimize manipulation of the Tested-Device;
- (c) Evaluate appropriateness of pass/fail criteria, e.g. how to differentiate smoke/fire emanating out of the initiation cell from smoke/fire occurring due to propagation;
- (d) Investigate if there is any impact on the test outcome arising from the manipulation of the Tested-Device.

22. Tests may cover cell, module, pack and vehicle level and, within the capabilities of predicting the research outcome and progress, development of a robust method for thermal propagation is expected in the 2018 or 2019 time frame. A dedicated research group will be formed in 2017 to perform this work.

23. The following test procedure that was developed jointly by China and Japan during Phase 1 of this UN GTR will be further evaluated and improved upon in Phase 2:

23A.1 Thermal propagation

In order to ensure the overall safety of vehicles equipped with a REESS containing flammable electrolyte, the vehicle occupants should not be exposed to the hazardous environment resulting from a thermal propagation (which is triggered by a single cell thermal runaway due to an internal short circuit).

Any one or more of the three recommended initiation methods shall be conducted (at the discretion of the manufacturer as long as the thermal propagation condition occurs) to verify that the hazard of the thermal propagation is prevented or eliminated by design.

23A.2. Thermal propagation test

The test shall be conducted in accordance with paragraph 23B.

- (a) If no thermal runaway occurs, the tested device meets thermal propagation requirement for the specific method of initiating thermal runaway. In order to ensure the prevention of thermal propagation, the manufacturer should verify that thermal runaway never occur by the remaining two candidate initiation methods described in 23B.3.2;
- (b) If thermal runaway occurs:
 - (i) Pack level test: If no external fire or explosion occurs within 5 minutes after the warning for a thermal event is activated³, the tested device meets thermal propagation requirement. The observation shall be made by visual inspection without disassembling the tested-device;
 - (ii) Vehicle level test: If no external fire or explosion and no smoke enters the passenger cabin within 5 minutes after the

³ If there is no warning device in the REESS under test, the logical protocol to activate the warning device should be described in the report that would indicate that the warning for a thermal event would activate before fire or explosion could be observed external to the pack.

warning for a thermal event is activated, the tested vehicle meets the thermal propagation requirement. The observation shall be made by visual inspection without disassembling the tested-device.

23B. Test procedures

23B.1. Purpose

The purpose of the thermal propagation test is to ensure the occupant safety in a vehicle if thermal runaway occurs in the battery system.

23B.2. Installations

This test shall be conducted either with the vehicle or the complete REESS or with related REESS subsystem(s) including the cells and their electrical connections. If the manufacturer chooses to test with related subsystem(s), the manufacturer shall demonstrate that the test result can reasonably represent the performance of the complete REESS with respect to its safety performance under the same conditions. In case the electronic management unit (Battery Management Systems (BMS) or other devices) for the REESS is not integrated in the casing enclosing the cells, it must be operational to send warning signal.

23B.3. Procedures

23B.3.1. General test conditions

The following condition shall apply to the test:

- (a) The test shall be conducted at temperature: 25 ± 2 °C;
- (b) At the beginning of the test, the state of charge (SOC) shall be adjusted according to paragraph 6.2.1.;
- (c) At the beginning of the test, all test devices shall be operational;
- (d) The test may be performed with a modified Tested-Device which is intended to minimize the influence of modification. The manufacturer should provide a modification list;
- (e) The test shall be conducted at an indoor test facility or in a shelter to prevent the influence of wind.

23B.3.2. Initiation method

Three different methods were selected as the candidate test methods to initiate the thermal runaway of a single cell in terms of practicability and repeatability.

A manufacturer may choose one of the candidate methods to initiate thermal runaway.

One of the candidate methods is heating: use a block heater, film heater or other heating device to initiate thermal runaway. In the case of a block heater at the same size of the component cell, one of the component cells is replaced with the heater. In the case of a block heater that is smaller than a component cell, it can be installed in the module contacting the surface of the initiation cell. In the case of a film heater, it shall be attached on the initiation cell surface.

The other two alternative methods are nail penetration and overcharge, which require a minimal modification to the battery system. The nail penetration test requires a hole to be pre-drilled in the enclosure of the battery system. The overcharge test requires the external wires to be attached to the initiation cell for overcharging:

- (a) Nail penetration: The test shall be conducted with the following conditions:
 - (i) Material: [Steel];
 - (ii) Diameter: [3mm or more];
 - (iii) Shape of tip: [Circular cone, Angle: 20-60°];
 - (iv) Speed: [0.1~10mm/s];
 - (v) Position and direction: Select the position and direction where causing a thermal runaway in a cell is possible (e.g. in vertical direction to electrode layer). Insertion from vent of a cell is possible if thermal runaway occurs. In this case, the cell that is perforated by nail is called the "initiation cell".

If no thermal runaway occurs and the nail penetration test stops, refer to paragraph 23A;

- (b) Heating: Heating shall be conducted with the following conditions:
 - (i) Shape: Planate or rod heater covered with ceramics, metal or insulator shall be used. Heating area of heater contacting the cell shall not be larger than area of cell surface wherever possible;
 - (ii) Heating procedure: After installation, the heater should be heated up to its maximum power. Stop the initiation when the thermal runaway occurs or the measured temperature following 23B.3.2 is over [300 °C]. The stop of initiation by heating should be reached within [30min];
 - (iii) Set position: Heating area of the heater is directly contacting the cell surface. Set the heater to conduct its heat to initiation cell. The heater position is correlated with the temperature sensor position, which is described in 23B.3.6.

If no thermal runaway occurs and the heating test is stopped, refer to 23A.

- [(c) Overcharge:

The initiation cell is overcharged at a constant current (1/3C~1C-rate, provided by manufacturer). Continue charging until thermal runaway occurs or the SOC of the initiation cell reaches 200 per cent SOC. Any other cells in the battery system shall not be overcharged.

If no thermal runaway occurs and the overcharge is stopped, refer to 23A.]

23B.3.3. Detection of thermal runaway.

Thermal runaway can be detected by the following conditions:

- (i) The measured voltage of the initiation cell drops;

- (ii) The measured temperature exceeds [the maximum operating temperature defined by the manufacturer];
- (iii) $dT/dt \geq [1 \text{ } ^\circ\text{C/s}]$ of the measured temperature.

Thermal runaway can be judged when:

- (a) Both (i) and (iii) are detected; or
- (b) Both (ii) and (iii) are detected.

If no thermal runaway occurs and the test stops, refer to 23A.

The definition of the measured temperature is in paragraph 23B.3.6.

23B.3.4. Selection of initiation method

Initiation method is selected by the manufacturer.

23B.3.5. Selection of initiation cell

Select an initiation cell, which is accessible by the selected trigger method described in paragraph 23B.3.2. and also whose heat generated by thermal runaway is most easily conducted to adjacent cells. For example, select the cell that is the nearest to the centre of battery casing or the cell that is surrounded by other cells which makes it difficult for the triggered cell to dissipate heat.

23B.3.6. Measurement of voltage and temperature

Measure the voltage and temperature in order to detect thermal runaway of the initiation cell.

In measuring voltage, the original electric circuit shall not be modified.

The measured temperature means the maximum temperature of Temperature A, as defined below. The accuracy of the temperature sensor shall be within $\pm 2 \text{ } ^\circ\text{C}$, and the sampling interval should be less than 1 s. The diameter of the tip of the sensor shall be less than 1 mm.

Temperature A: The maximum surface temperature of the initiation cell measured during the test.

As for the test set-up of the nail, place a temperature sensor as close to the short circuit point as possible (see Figure 1).

Figure 1
Example of set positions of temperature sensor in Nail

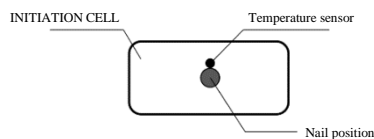

Note: As for overcharge, place a temperature sensor on the cell surface equidistant between and as close as possible to both battery terminals:

Figure 2
Example of set positions of temperature sensor in Overcharge

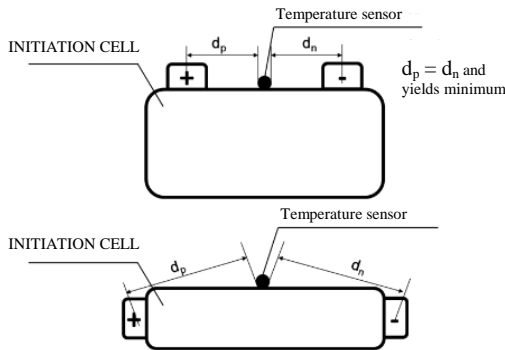

Note: As for the set-up using a heater, place a temperature sensor on the far side of heat conduction, for example, an opposite side of the position where heater is placed (see Figure 3). If it is difficult to apply the temperature sensor directly, place it at the location where the continuous temperature rise of initiation cell can be detected.

Figure 3
Example of set positions of heater and temperature sensor in Heating

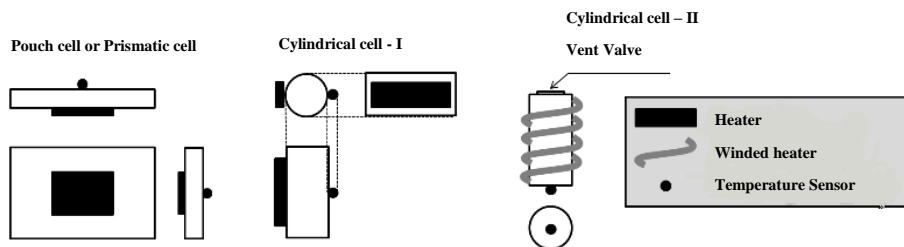

D. Principle for developing the global technical regulation

24. This UN GTR addresses the unique safety risks posed by EVs and their components, considering the following points:

- (a) To ensure a safety level equivalent to conventional vehicles with internal combustion engine and to prevent EV-specific hazardous events, assuming a reasonable level of the robustness;
- (b) To identify and assess the potential safety risks, depending on the relevant vehicle conditions such as:
 - (i) in normal use, in active driving possible mode and parking;
 - (ii) in normal use, during external charging/feeding;
 - (iii) in an accident (during and post-crash).

- (c) To consider the safety validation of the entire battery system of the vehicle (e.g. BMS);
- (d) To be performance-based to the extent possible without disturbing future technology development;
- (e) To be reasonable, practicable and effective;
- (f) To develop and validate test procedures that are repeatable and reproducible, taking account for the difference of dimensions, configurations and materials (e.g. type of REESS) of the relevant EV on usage;
- (g) The safety during the external charging/feeding may not be ensured through the legal requirement on the vehicles. Therefore, the informal working group will aim to establish the overall safety of the vehicle and the external charging/feeding infrastructure in a comprehensive manner by showing the accountability of vehicles to the related stakeholders.

25. This UN GTR was developed to accommodate different types of vehicle certification processes. The following are examples of two primary systems used by Contracting Parties.

1. Self-Certification system in the United States of America

26. It is the responsibility of a manufacturer of vehicles and/or items of motor vehicle equipment to certify that each motor vehicle and/or equipment item is in full compliance with the performance requirements of all applicable Federal Motor Vehicle Safety Standards (FMVSS). The FMVSS specify test methods and conditions that would be used to assess compliance of a vehicle or motor vehicle equipment to applicable FMVSS. However, manufacturers may use alternative methods to certify their vehicles. Manufacturers using alternative methods to certify their vehicles and equipment are responsible for ensuring that the vehicles and equipment would comply with the requirements of applicable FMVSS when evaluated by the methods specified in the FMVSS.

27. The manufacturer must not only be concerned with the initial certification, but should also monitor continued compliance of vehicles and/or items of motor vehicle equipment throughout the production run. The American government does not specify the type of quality control programme that a manufacturer should employ. That decision is left to the manufacturer. However, to accomplish this, an effective quality control program should be established to periodically inspect and test vehicles and/or items of motor vehicle equipment randomly selected from the assembly line to ensure that the original performance is carried through to all other units

2. Type Approval Process system of the European Union

28. The European Union approval scheme is based on the concept of 'type approval' and conformity of production where this process provides a mechanism for ensuring that a type of vehicle and its components meet the relevant environmental and safety requirements. The type of vehicle and its components is required to be certified and approved by a designated national approval authority⁴ before it is offered for sale in a particular country (not necessarily the same country where type approval is obtained). This certification includes testing, certification, and production conformity assessment. Once approved, the

⁴ According to Annex I of ECE/TRANS/WP.29/343/Rev.26 - Status of the Agreement, of the annexed Regulations and of the amendments thereto - Revision 26

whole vehicle can be sold throughout Europe Union (EU) with no further test approval needed. The manufacturer has to provide each vehicle with a declaration (certificate of conformity) that the vehicle complies with the approved vehicle type and the type-approval authority shall check the conformity of production.

29. In accordance with the provision of the 1958 Agreement which concerns the Adoption of Uniform Technical Prescriptions, an approval of parts and equipment of a vehicle issued by a designated national Approval Authority (can be non-EU) based on UN Regulations will be accepted in all EU member States and other Contracting Parties to the 1958 Agreement (e.g. Japan, Russian Federation) as an equivalent to domestic approval. Therefore, parts and equipment approved under UN Regulations are recognized for the EU approval of the whole vehicle.

E. Technical rationale and justification

1. Application/Scope

30. The application of the requirements of this UN GTR refers to the revised vehicle classification and definitions outlined in the 1998 Global Agreement Special Resolution No. 1 (S.R.1) concerning the common definitions of vehicle categories, masses and dimensions.

31. Given that higher production volumes in the near future are expected for light and heavy motor vehicles with electric powertrains, with these vehicles exhibiting similar potential safety risks under similar operating conditions, this regulation addresses expected performance requirements that are pertinent for vehicle categories 1 and 2.

32. In some regions of the world, low-mass, speed-restricted vehicles which operate only in lower speed environments do not need to meet the high safety levels mandated for higher speed vehicles, such as M and N categories, which operate in all speed environments including high speed ones.

33. Similarly, in some regions of the world, low-mass vehicles, which can operate in all speed environments are currently lightly regulated and/or benefit from relaxed safety requirements. Further regulatory alignment with M and N vehicle categories is required with a view to meet the high safety levels mandated for higher speed vehicles, because they are likely to be involved in accidents at these higher speeds.

34. Moreover, further work is required to perform a comprehensive cost benefit analysis and to detail changes or adaptations to test protocols and relevant requirements that would be necessary to directly apply M vehicle category regulations to the "car-like" category of low mass vehicles, which have an enclosed passenger compartment.

35. Therefore, 1998 Ag. C.Ps. may decide to exclude from the application of this UN GTR:

- (a) All vehicles with four or more wheels whose unladen mass is not more than 350 kg, not including the mass of traction batteries, whose maximum design speed is not more than 45 km/h, and whose engine cylinder capacity and maximum continuous rated power in the case of hybrid electric vehicles do not exceed 50 cm³ for spark (positive) ignition engines and 4 kW for electric motors respectively; or whose maximum continuous rated power in the case of battery electric vehicles does not exceed 4 kW; and
- (b) Vehicles with four or more wheels, other than that classified under a) above, whose unladen mass is not more than 450 kg (or 650 kg for vehicles intended

for carrying goods), not including the mass of traction batteries and whose maximum continuous rated power does not exceed 15 kW.

36. Whereas the heavy vehicle industry is behind the passenger vehicle industry in terms of developing vehicles with electrified drive trains, recent years has seen a steady increase in the number of buses and trucks with Hybrid Electric Vehicles (HEV), Plug-in Hybrid Electric Vehicle (PHEV), Fuel Cell Vehicles (FCV) and pure Battery Electric Vehicle (BEV) designs on the market. Currently, the heavy vehicle industry employs similar battery technology solutions in their products as the passenger car industry. Hence, the informal working group decided to investigate to what extent the requirements in this regulation could be applied to heavy vehicles, i.e. Categories 1 and 2 vehicles with a Gross Vehicle Mass (GVM) exceeding 4,536 kg.

37. It was decided to dedicate separate chapters of this regulation to heavy vehicles for four reasons:

- (a) The Contracting Parties and the passenger vehicle industry voiced a common concern that the technical deliberations would be slowed down with the introduction of heavy vehicles into the scope and, hence, jeopardize the overall timeline for development of this regulation. The solution was to form a separate task force to evaluate the applicability of test and requirements from the sole perspective of heavy vehicles, and to propose alterations and exemptions, when appropriate;
- (b) The comprehensiveness and user-friendliness is improved by keeping the passenger vehicles and light commercial vehicles platforms separate from heavy duty vehicles, due to inherent technology differences and the need to adapt the regulatory requirements accordingly;
- (c) The development direction of REESS, system integration and related technology solutions is likely to differ from that of the passenger car technology in the future, e.g. choice of battery technologies and optimization of performance characteristics, charging solutions, etc. This trend is already starting to show in charging technologies, where the heavy vehicle industry is moving in a direction to minimize human involvement in charging operations, e.g. pantographs, inductive charging plates, electrified roads, etc. Separating requirements for the heavy vehicles in this regulation facilitates future revisions, when the technical differences between these vehicle segments are more pronounced;
- (d) 1998 Ag. C.Ps., have requested to make adoption of the regulation on heavy vehicles a Contracting Party option, which is simplified by separating the heavy vehicles in the regulatory text.

38. A significant difference between passenger car and heavy vehicle manufacturers is that the latter to a larger extent can be characterized as vehicle integrators. It is common for a heavy vehicle manufacturer to produce both complete and incomplete vehicles, e.g. chassis. The incomplete vehicles are further developed by another party, responsible for building the body structure. It is also common for heavy vehicles, especially trucks, to change application area and, therefore, be rebuilt with different body structures during different phases in the service life. Consequently, implications, conditions and limitations of vehicle based testing needs to be considered in detail for heavy vehicles, especially considering incomplete vehicle compliance.

39. An additional feature of the heavy vehicle business model is that there is an overabundance of variations of vehicles built around a range of similar chassis, each designed/customized to fit a specific application and customer need. REESS positioning,

orientation and fastening will depend on the specific design elements and limitations of the application and customer specifications. The option of component based testing is, therefore, essential for heavy vehicles and vehicle-based tests should be avoided as far as possible in order to prevent creating an excessive and unmanageable test load. In the exceptional case that it is not possible to evaluate performance on a component level and a vehicle test is unavoidable, there must be an established model for selecting a limited set of representative vehicle designs to test for compliance of the entire range. The principles for the selection model will, by nature, have to be test specific and based on the defined test objective.

40. Furthermore, when extending the scope of this regulation to include heavy vehicles, it is imperative to ensure that the performance requirements that are established as appropriate for passenger vehicles do not become technology limiting for heavy vehicle development. This is particularly important for criteria with high potential of becoming market normative for components.

2. Requirements of a vehicle with regard to its electrical safety

(a) Rationale for electric safety requirements

41. A failure of a high voltage system may cause an electric shock to a (human) body. Such a shock may happen with any source of electricity that causes a sufficient current flow through the skin, muscle or hair. Typically, the expression "electric shock" is used to denote an unwanted exposure to electricity, hence the effects are considered undesirable.

42. The minimum current a human can feel depends on the current type (AC or DC) and frequency. A person can feel at least 1 mA (rms) of AC at 60 Hz, while at least 5 mA for DC. The current may, if it is high enough, cause tissue damage or fibrillation, which leads to cardiac arrest: 60 mA of AC (rms, 60 Hz) or 300–500 mA of DC can cause fibrillation.

43. A sustained electric shock from AC at 120 V, 60 Hz is an especially dangerous source of ventricular fibrillation because it usually exceeds the let-go threshold, while not delivering enough initial energy to propel the person away from the source. However, the potential seriousness of the shock depends on paths of the current through the body.

44. If the voltage is less than 200 V, then the human skin is the main contributor to the impedance of the body in the case of a macro-shock passing current between two contact points on the skin. The characteristics of the skin are non-linear however. If the voltage is above 450–600 V, then dielectric breakdown of the skin occurs. The protection offered by the skin is lowered by perspiration, and this is accelerated if electricity causes muscles to contract above the let-go threshold for a sustained period of time.

(b) In-Use requirements

45. "In-Use Requirements" are the specifications that have to be fulfilled to avoid electric hazard to occupants of an electric vehicle during normal operating conditions (i.e., no crash or fault conditions).

46. The requirements focus on the electric power train operating on high voltage as well as the high voltage components and systems that are galvanically connected.

47. To avoid electrical hazards, live part(s) (conductive part(s) intended to be electrically energized in normal use) are protected against direct contact.

48. Protection against direct contact inside the passenger compartment is verified by using a standardized Test Wire (IPXXD) (see Figure 4).

Figure 4
Standardized Test Wire



49. Outside the compartment a standardized Test Finger (IPXXB), shown in Figure 5, is used to check whether a contact with live parts is possible or not.

Figure 5
Standardized Test Finger



50. Furthermore exposed conductive parts (parts which can be touched with the standardized Test Finger and becomes electrically energized under isolation failure conditions) have also to be protected against indirect contact. This means that e.g. conductive barriers or enclosures have to be galvanically connected securely to the electrical chassis.

51. Beside protection against direct and indirect contact, isolation resistance is required for AC (Alternating Current) and DC (Direct Current) systems. Isolation resistance measured against the electrical chassis is a physical dimension describing which maximum current flowing through the human body is not dangerous.

52. While DC systems are less harmful to the human body (see paragraph 5.1.1.2.4.1.), 100 Ω/V are required. AC systems have to fulfil 500 Ω/V .

53. The isolation resistance requirements of 100 Ω/V for DC or 500 Ω/V for AC allow maximum body currents of 10 mA and 2 mA respectively.

(c) *Requirements during charging*

54. Vehicles with REESS that can be charged by conductively connecting to an external grounded electric power supply must have a device that conductively connects the electrical chassis to the earth ground during charging. This ensures that if there is a loss in electrical isolation of the high voltage source during charging, and a human connects the vehicle chassis, the magnitude of current flowing through the person is very low and in the safe zone. This is because current will flow through the path of least resistance and therefore most of the current resulting from a loss of electrical isolation would flow through the ground connection rather than through the human body.

55. The electrical isolation from the chassis of high voltage sources that are connected to the vehicle charge inlet during conductive charging (by connecting to AC external electric power supply), must be greater than or equal to 500 Ω/V . This ensures that the leakage current during charging will be less than that needed to trip the Residual Current Device (RCD) or the Charging Circuit Interrupting Device (CCID) during charging. During

charging by connecting to external AC electric supply, the protection measures are the RCD and CCIDs that are located in the off-board electric vehicle supply equipment (i.e. charge connector). The 500 Ω/V electrical isolation of high voltage sources is only needed to ensure sufficiently low levels of leakage current such that the RCDs and CCIDs are not tripped during normal charging conditions. Requirements for RCDs and CCIDs are specified by national and international electric standards such as the National Electric Code (NEC) – Article 625, Underwriters Laboratory (UL) 2954 and adopted in different country and state laws. Therefore, there may not be a need to specify requirements for RCDs and CCIDs in the charge connectors in this regulation. Each Contracting Party may assess the need based on the electric code requirements in their respective countries.

(d) *Post-crash requirements*

56. Post-Crash requirements are the specifications that have to be fulfilled by the vehicles after the impact to avoid any electric hazard to passengers of the vehicle or first responders. They do not describe how the impact has to be conducted. This is the responsibility of each 1998 Ag. CPs.

57. The requirements are focused on the electric power train operating on high voltage as well as the high voltage components and systems which are galvanically connected to it.

58. After the impact of the vehicle the following four measures demonstrate that the systems are safe. It means that the remaining "electricity level" of the high voltage systems are no longer dangerous to the vehicle occupants and first responders.

3. Rationale for the criterion 'absence of high voltage'

59. Most electric vehicle designs use electrical contactors to disconnect high voltage from the propulsion battery in the event of a crash or other loss of isolation. The electrical isolation test procedure is inappropriate for such designs, because the voltage differential between the high voltage system and the chassis would be zero, which would put a zero in the denominator of the equation to calculate isolation.

60. There appears to be agreement that low voltage (voltages of less than 60V DC or 30V AC) is an acceptable option for providing post-crash electric safety. The 2005 revision to SAE J1766 corrected this oversight by explicitly recognizing low voltage as a second option for post-crash electric safety. This option was also subsequently adopted in FMVSS 305. The last amendment of UN Regulations Nos. 12, 94 and 95 also adopted this as an alternative to isolation resistance.

4. Rationale for the low energy criterion

61. Background and terminology: The initial resistance of the human body, denoted as R_i in this rationale, plays a pivotal role in the calculations that follow. R_i is a variable that is based on a number of factors, and therefore it can in practice encompass a wide range of values. Since the severity of an electrical hazard to a human generally increases as the current through the body increases, and since current is inversely proportional to skin resistance per Ohm's law, this document is generally concerned with the minimum realistic value of R_i which corresponds to the lowest energy level that could cause harmful effects. This rationale uses a minimum value of R_i of 500 Ω based on paragraph 4.6 of International Electrotechnical Commission (IEC) TS 60479-1: 2005.

62. Rationale for an Energy Limit: From both physiological and practical standpoints, there are compelling reasons why a low energy limit is an appropriate option for providing post-crash electrical safety. The first rationale is one of completeness. There is broad consensus in the literature that electrical energy, even high voltage electrical energy, does not expose a human to any long-term, harmful effects provided the total energy delivered to

the human is sufficiently low. A second reason to include the low-energy option involves practical implementation issues of designing high voltage systems that comply with the high-isolation or low-voltage criteria. Automotive high-voltage systems typically utilize a number of capacitors connected to high voltage buses, and it is not always practical to discharge every capacitor post-crash. By providing guidance on a safe energy limit, vehicle manufacturers will have the needed flexibility to design products that assure safety without imposing unnecessary and burdensome costs.

63. Establishment of Appropriate Body Resistance Values: The initial resistance of the human body, denoted as R_i in this rationale, plays a pivotal role in the calculations that follow. R_i is a variable that is based on a number of factors and in practice can encompass a wide range of values. Since the severity of an electrical hazard to a human generally increases as the current through the body increases and the current is inversely proportional to skin resistance (Ohm's law), calculations to determine appropriate limits for maximum energy levels are based on values of R_i that reflect realistic contact/exposure scenarios that are likely to be encountered in the real world.

64. When evaluating the risk associated with electrical impulse (e.g. capacitor discharge), the body resistance is a function of the voltage at the initiation of the electrical impulse. In the real world case of capacitive discharges, the voltage is the highest at the beginning of the pulse and drops as the capacitor discharges.

65. Table 10 in IEC TS 60479-1 details total body resistances R_t for a hand-to-hand current path, large surface areas of contact, and in dry conditions. For wet contact conditions, the values contained in Table 2 (of IEC TS 60479-1) would be sufficiently accurate/conservative for direct current. Hand-to-hand contact is the most representative of the type of contact that would be expected in real world contacts with electric vehicles. IEC TS 60479-1 also contains information that permits calculation of internal body resistances and ventricular fibrillation risk levels (heart factors) for other body contact/current paths through the human body.

66. The lowest internal body resistance is obtained in a "hand to two feet" contact scenario. However, this scenario is highly unlikely, since first responders and others, likely to contact a vehicle post-crash would be wearing protective (and insulating) footwear. In addition, in order to complete the circuit (and be exposed to harmful electrical current), the person would need to simultaneously place their foot and hand on separate parts of a vehicle with different electrical potentials. They would not be subjected to harm by simply contacting the vehicle with their hand, with their feet placed on the ground.

67. In this analysis, we calculate the shock risk for both scenarios and note that they both are in the acceptable risk zones outlined by IEC TS 60479-1. Table 1 below provides a comparison of the fifth per cent of population, large area of contact, wet, hand-to-hand body resistances with the most conservative fifth per cent of population, large area of contact, wet, hand-to-two feet body resistances.

68. For the lowest 5 per cent of the population, body resistances for large area of contact, wet, hand-to-hand contact range from 1,175 Ω for 25 V to an asymptotic value of 575 Ω for voltages $\geq 1,000$ V dc. When, these values are adjusted to large area of contact, wet, hand-to-feet contact, body resistances range from 1,022 Ω at 25 V dc to 500 Ω at voltages $\leq 1,000$ V dc. Table 1 below provides the body resistance values used in this analysis as a function of the initial (highest) voltage present when the electrical impulse (capacitive discharge) is initiated.

Table 1
Maximum Total Body Resistance for the fifth per cent of Population for Large Area Contact Under Wet Conditions Between Hand-to-Hand and Hand-to-Feet by Contact Voltage

Voltage (V)	<i>Total body resistance (R_t) that are not exceeded for 5 per cent of the population</i>	
	Large area/hand-to-hand/ wet (Ω)	Large area/hand-to-feet/ wet (Ω)
25	1 175	1 022
50	1 100	957
75	1 025	892
100	975	848
125	900	783
150	850	740
175	825	718
200	800	696
225	775	674
400	700	609
500	625	544
700	575	500
1 000	575	500

69. Derivation of Energy Limit: Assuming constant body resistance during a capacitor discharge event, the body current will decay exponentially over time (see Figure 6). When assessing the electric shock risks for capacitive discharges, both the body current and duration of discharge pulse determines the risk to a human. Specifically, discharge pulses less than 10 ms in duration utilize the threshold of ventricular fibrillation thresholds given in Figure 20 of IEC TS 60479-2, while discharge pulses longer than 10 ms utilize the values given in Figure 22 of IEC TS 60479-1. Figure 6 below illustrates the decaying body current – time relationships for 0.2 J capacitors for hand-to-hand contact resistances. Note that the higher the initial voltage, the shorter the time duration for the discharge impulse is.

Figure 6
Body Current Versus Time of 0.2 J Capacitors for Large Area Hand-to-Hand Contact under Wet Conditions and Different Contact Voltages

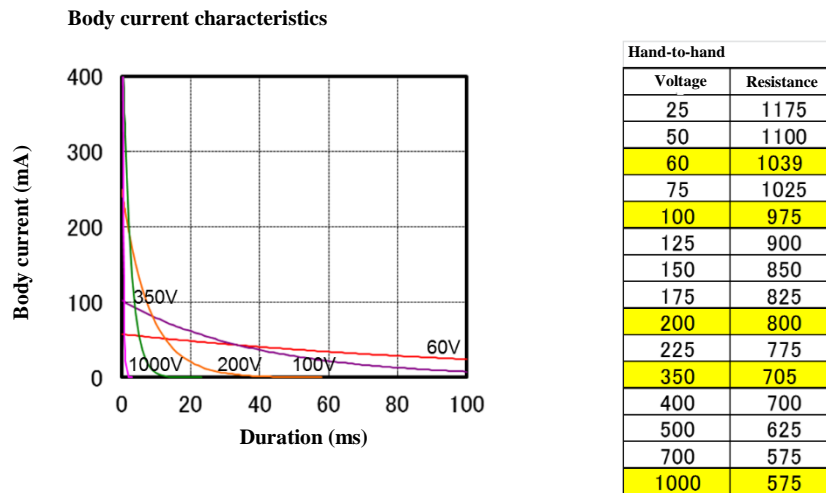

70. Depending upon the initial charge level, the time durations of these pulses can exceed 10 ms. As a result, the DC risk curves as well as the ventricular fibrillation risk curves need to be jointly considered.

71. While instantaneous body currents can be compared to the IEC TS 60479-1 and IEC TS 60479-2 risk curves, a more realistic assessment of risk should account for the time history of the body current throughout the discharge event. As a result, international standards account for this increased risk by calculating the root-mean-square (rms) body current and comparing that current to the appropriate risk boundaries. IEC and SAE use slightly different methods for making this calculation. IEC TS 60479-2 provides a simple calculation (see Figure 7) that results in a single point value at 3T current. SAE integrates the discharge body current/time history over the time duration where the body current is greater than 2 mA (below which body current is deemed to be benign). This provides a continuous function that can be compared to the risk curve boundaries at any point during its discharge. Figure 7 below illustrates the IEC and SAE methods.

Figure 7
Root-Mean-Square Current ($i_{(rms)}$) computation using the IEC TS 60479-2 and the SAE methods

- IEC60479-2: $i_{(rms)} = i_{(peak)}/\text{sqrt}(6)$ (this results in a single point value)

$$\text{SAE: } i_{(rms)} = \sqrt{\frac{\int_0^T i(t)^2 dt}{T}} \text{ (Continuous function that can be evaluated at any point).}$$

Figure 8
Body Current for 0.2 J and 200 V Capacitor under Large Area Hand-to-Hand Contact Under Wet Conditions (800 Ω Body Resistance)

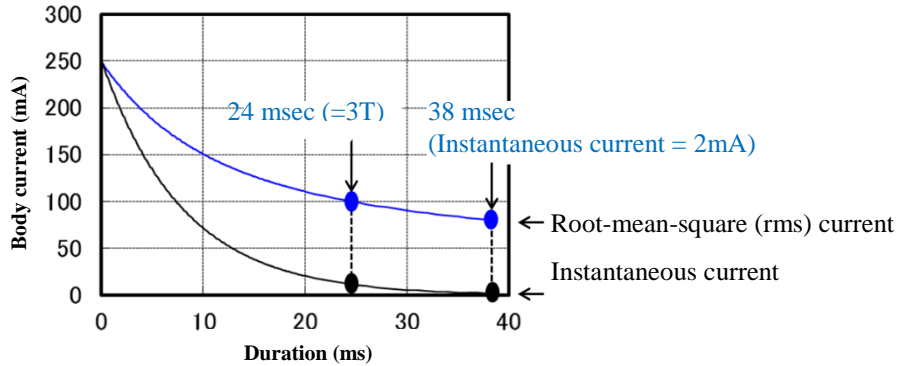

72. Figure 8 above, compares the instantaneous body currents versus the rms body currents for a 200V, 0.2 J capacitor discharge using both the IEC formula (calculated at a point where the pulse duration is equal to 3T) and the SAE method which terminates when the instantaneous current drops below 2mA. Note that both the instantaneous and rms curves start from the same value but they diverge as the pulse duration increases. This makes sense since the rms curve accounts for the increased risk effects associated with increasing pulse duration.

Figure 9
Root-Mean-Square (rms) Body Current, 0.2J Capacitors, Large area/wet/hand-to-hand body resistance

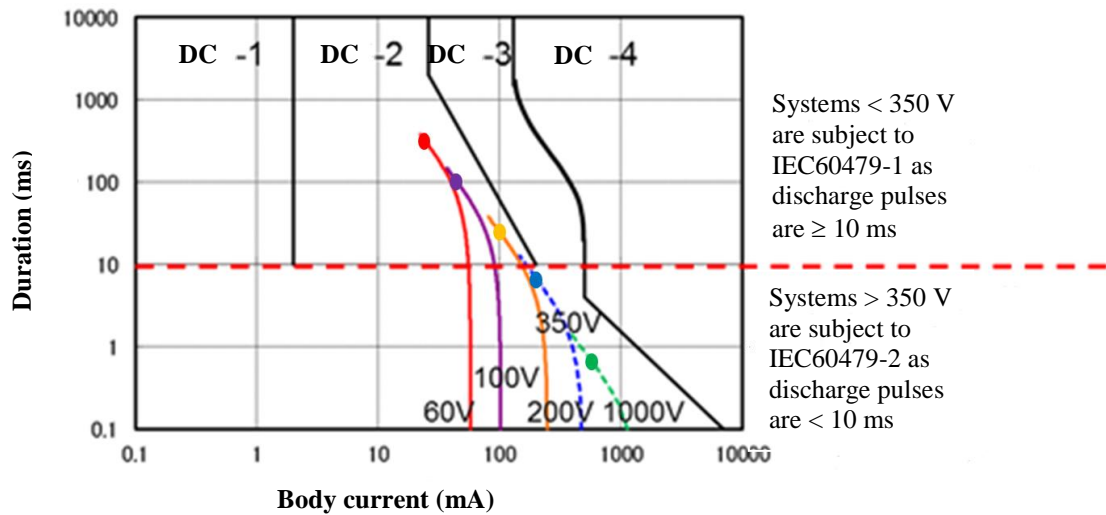

73. Figure 9 above plots rms body currents for 0.2 J capacitive discharges for initial charge voltages ranging from 60V to 1,000V. The coloured curves were generated using the SAE method and the coloured dots represent the points calculated using the IEC TS 60479-2 formula. As can be seen in this figure the two calculation methods yield the same results at the IEC method calculation point (3T duration).

74. In addition, 0.2 J capacitors with charge voltages less than 350 V will have discharge pulses greater than 10 ms and thus are subject to risk boundaries specified in IEC TS 60479-1. Likewise, 0.2 J capacitors with charge voltages greater than 350 V will have discharge pulses less than 10 ms and are subject to risk boundaries specified in IEC TS 60479-2.

75. From these calculations, the maximum capacitor energy level that will not exceed the DC-2 and C1 boundary is 0.28 J. This level is 40 per cent greater than the 0.2 J limit prescribed in the UN GTR requirements. It is important to note that both the IEC and SAE methods yield results that do not exceed the DC-2 and C1 boundaries.

76. Repeating the above calculations using hand-to-feet body resistance (highly unlikely encountered in real-world contact situations) gives a limit value of 0.25 J, which is 25 per cent greater than the 0.2 J limit prescribed the requirements. The 0.25 J limit matches that prescribed in the most recent revision of the United States Department of Energy Electrical Safety Handbook (DOE-HDBK-1092-2013).

77. In setting the 0.25 J threshold contained in the 2013 version of the "DOE Handbook", the authors cited a study that analysed the reflex response threshold of electrostatic discharge shocks. This study⁵, plus others referenced in IEEE the paper identified the 0.25 J threshold as the beginning of nuisance reflex action. The authors cite experience by many indicating that a high voltage capacitor shock above 1 J is not desirable. By 10 J the reflex action can become so severe that a person can be injured from muscle contractions.

78. The DOE classification of the hazards of high voltage capacitors benefited greatly from the studies of impulse shock and from the development of various forms of the defibrillator. Other than electrostatic discharge shocks (which can cause ignition of combustible materials, but not adverse electrical shock) the high voltage group (>400V) is ranked in a graded manner using 5 breakpoints. The lowest risk group (colour coded green) is the < 0.25 J group, which can cause nuisance reflex action but will not cause injury (either due to shock or muscle reflex).

79. A high voltage capacitor shock from 0.25 J to 1 J will cause a significant reflex action, possibly causing injury from the reaction. Contact with this category, although not potentially lethal, should be avoided and is appropriately colour coded yellow. The range from 10 J to 1000 J includes possible death due to ventricular fibrillation, as well as damage to nerve pathways and other tissue damage and thus is colour coded red.

80. In summary, the 0.2 J limit provides adequate margin from the beginning of "nuisance reflex action" and significant margin from the onset of potentially lethal effects such as ventricular fibrillation].

5. Rationale for the Physical Protection Criterion

81. The physical protection criterion is necessary because EVs may use capacitors that take time to discharge. As a result, physical barriers are necessary to shield high voltage components from human contact during the time that such capacitors remain at high voltage. Since crash test requirements include test speeds that may not generate crash pulses that would reliably open electrical contactors, the low voltage compliance alternative may not be a viable compliance strategy.

⁵ Y. Liu, Z. Wu, and S. Liu, "Threshold of Perception for Capacitor Discharge on the Human Body", Proceedings of the 1997 International Symposium on Electromagnetic Compatibility, pp 340-343, IEEE.

82. Furthermore, DC components of the fuel cell in a fuel cell vehicle (FCV) can connect with the AC components through the inverter (even when the vehicle is stationary). After certain crash tests that may not result in the opening of the contactors (i.e. when the contactors are closed and the DC and AC components are connected), the isolation resistance at the AC component is parallel with the isolation resistance of the DC component fuel cell. Therefore, even if the electrical isolation provided for the AC component is significantly greater than the required 500 Ω/V , the effective isolation resistance measured at the AC component can be, at most, as high as that provided for the DC component fuel cell, which is in turn limited by the fuel cell coolant. Therefore, it may not be practical to achieve the required 500 Ω/V electrical isolation for AC components.

83. The physical protection criterion provides human isolation from high voltage live parts via electrical protection barriers to ensure that there is no direct or indirect human contact with high voltage live parts during normal vehicle operation or after a vehicle crash. Specification of the 0.1 Ω upper resistance limit for chassis bonding provides protection from electric shock by shunting any harmful electrical currents to the vehicle chassis should any electrically charged components lose isolation within the protective barrier.

84. For in-use protection against direct contact with high voltage components test probes are specified that conform to ISO 20653 "Road vehicles – Degrees of protection (IP-Code) – Protection of electrical equipment against foreign objects, water and access". For enclosures contained inside the passenger and luggage compartments, a 1.0 mm diameter and 100 mm long test wire probe is specified (IPXXD). This test probe ensures that any gaps in the protective barriers are no larger than 1.0 mm and that any live components contained within are no closer to the gap than 100 mm. This ensures that body parts, miscellaneous tools or other slender conductive items typically encountered in a passenger or luggage compartment cannot penetrate any gaps/seams in the protective enclosures and contact high voltage components contained within.

85. For protection against contact with live parts in areas other than the passenger and luggage compartments, and for post-crash conditions a test probe designed to simulate a small human finger (12 mm) is specified (IPXXB). In such conditions, potential contact with the barriers will not include potential items rolling around (as in a passenger or luggage compartment). Therefore, protection using the wire probe is not necessary and the human finger probe (IPXXB) is appropriate to prohibit inadvertent contact with high voltage components contained in the protective enclosures by mechanics and first responders.

86. Analysis of Issues with Indirect Contact: As part of National Highway Traffic Safety Administration's (NHTSA) evaluation of the Hydrogen and Fuel Cell Vehicles (HFCV) UN GTR No. 13, the agency has conducted research examining the efficacy of the physical barriers compliance alternative for both, direct and indirect contact. This analysis generally confirmed the efficacy of the barriers alternative for protection against direct contact.

87. However, research by NHTSA identified a potential scenario (see Figure 10) where the agency was concerned that a human could potentially receive harmful levels of electrical current from indirect contact with the barriers when there is a simultaneous loss of isolation from opposite rails of the high-voltage bus in separate barriers. Many 1998 Ag. CPs, have examined the likelihood of this scenario and concluded the risk for exposure to shock to be very low in the real world. However, at least one Contracting Party felt that there should be additional performance requirements to address this scenario (even if remote). As a result, specifications limiting the maximum voltage between exposed conductive parts of high voltage physical protection barriers were developed. Since, some 1998 Ag. CPs were not convinced that the additional requirements are necessary, these specifications have been implemented as an option for the Contracting Parties.

Figure 10
Potential risk scenario of indirect contact

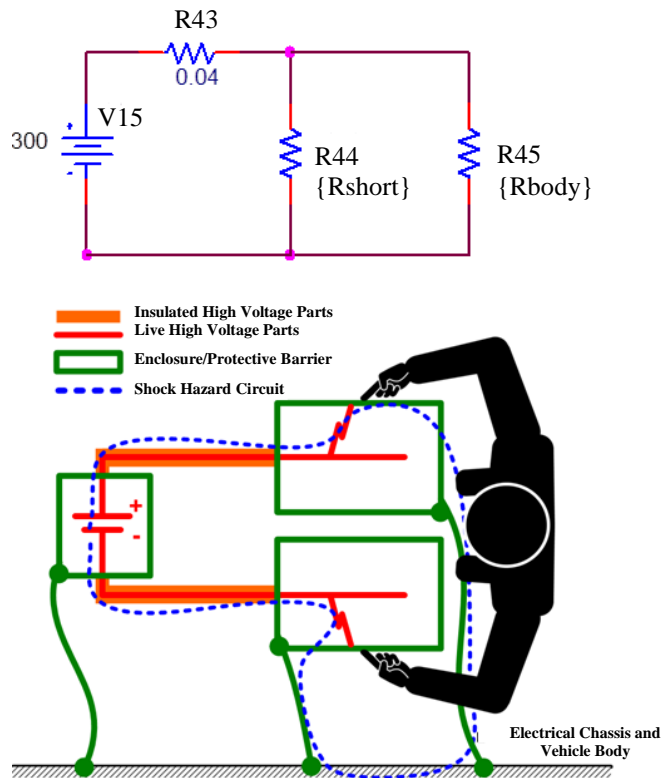

6. Rationale for the isolation resistance criterion

88. The electrical isolation (Ω/V) is a measure of a material's resistance to electrical current passing through it. Thus, a higher electrical isolation means that less current passes through. The electrical isolation of a high voltage source in the vehicle is determined by the electrical resistance between the high voltage source and any of the vehicle's electrical chassis divided by the working voltage of the high voltage source.

89. Maintaining electrical isolation ensures that the high voltage system does not use the chassis itself to complete (or close) the circuit. This makes it less likely that a human or other object could touch the chassis and become part of the circuit, allowing electrical current to flow through them. It is intended to protect occupants, rescue workers/first responders, or others who may come in contact with the vehicle after a crash from electrical shock hazards, by ensuring isolation of the vehicle's high voltage battery electrical system.

90. Electrical isolation, in units of Ω/V , can be derived from Ohm's law ($V=I \cdot R$) and is given below. The current flow through the body can be expressed in terms of electric isolation:

$$\text{Resistance } (\Omega) / \text{Voltage } (V) = 1 / \text{Current } (A)$$

91. Rationale for AC: The value of 500Ω comes from the paragraph 4.6 of the IEC 60479-1:2005. Also this value is 0.87 times of 575Ω that is described in the table 1 to 3 of IEC TS 60479-1:2005 as the lowest value of the body impedance for the current path "hand to hand". "0.87" is thought to be reasonable because IEC TS 60479-1:2005 says that the body impedance for the current path "hand to foot" is somewhat lower than for a current path hand to hand (10 per cent to 30 per cent). For example, a 300 V system would be

required to have 150,000 (300 X 500) Ω resistance between the vehicle's propulsion battery and chassis after a crash test.

92. Rationale for DC: The safety justification for adopting the electrical isolation requirement of 100 Ω/V for the DC electrical buses derives from the fact that DC current is less harmful than AC current.

93. IEC TS 60479-1:2005 presents data on human physiological response based on current flow through the human body, over time. Figures 11 and 12 are copied directly from IEC TS 60479-1. They show AC and DC effects respectively. The shock duration ranges from 10 ms to 10,000 ms and the current level ranges from 0.1 mA to 10,000 mA. Physiological responses are separated into four zones for each graph.

Figure 11
Conventional time/current zones of effects of AC currents (15 Hz to 100 Hz) on persons for current path corresponding to left hand to feet (Figure 20 from IEC TS 60479-1)

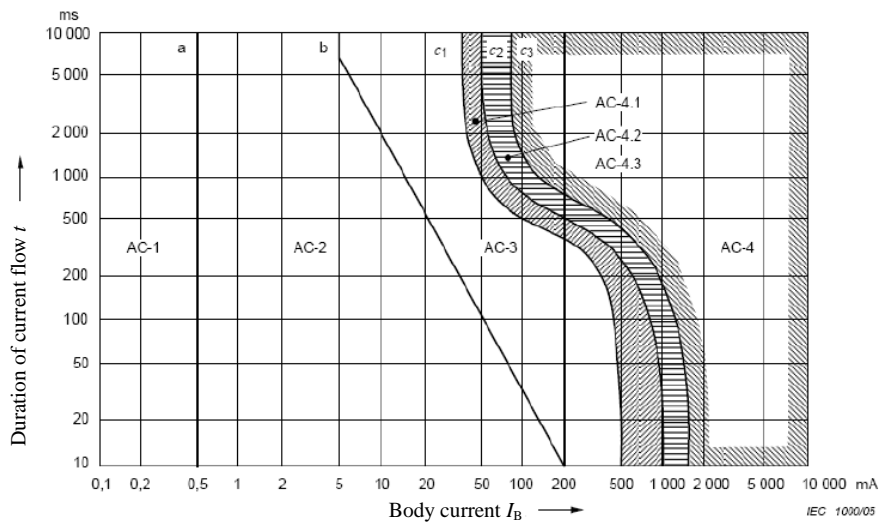
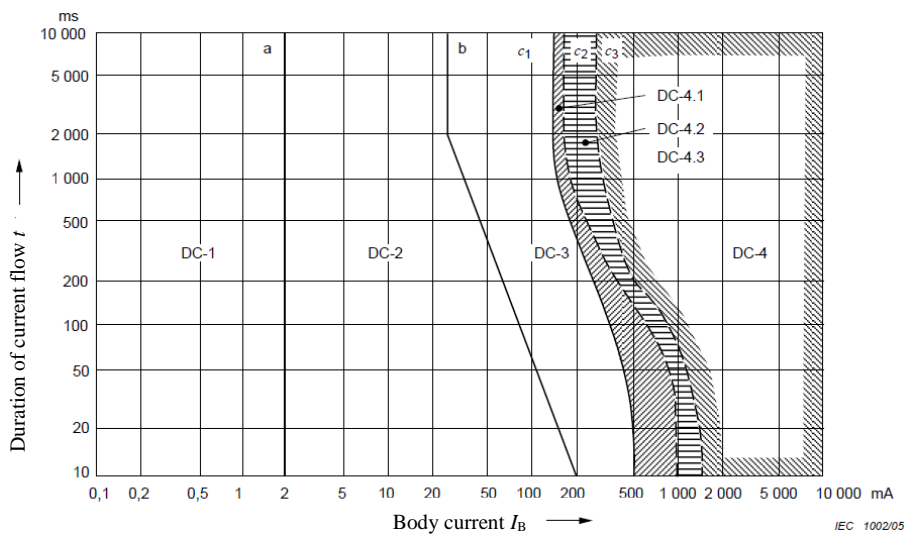

Figure 12
Conventional time/current zones of effects of DC currents on persons for current path corresponding to left hand to feet (Figure 22 from IEC TS 60479-1)



94. Assuming that zones AC-2 and DC-2 represent the same physiological responses, then it is reasonable to expect that the response at the upper and lower boundary is the same. If the analysis is restricted further to an evaluation of the worst case duration (10 s), then points along the 10 s duration line in zone 2 represent a gradation of physiological response between the boundaries. Then, corresponding points along this line in AC-2 and DC-2 can be mapped and represent the best estimate of the likely physiological response.

95. Data published by the International Electrotechnical Commission (IEC) shows that 500 Ω/V isolation for AC is in the mid-range of zone 2 along a progressive scale depicting the physiological effect of exposure. Similarly, 100 Ω/V for DC is also in the mid-range of zone 2 on the DC chart. In other words, 100 Ω/V DC provides equivalent safety to 500 Ω/V AC. Table 2 below shows the AC and DC current values and electrical isolation for the boundary of zone 2 and the calculated electrical isolation threshold using the log-log and lin-lin assumptions. The table also shows the ratio of DC over AC current.

Table 2

Body Current Threshold Values for AC and DC High Voltage Source for Different Isolation Resistance Values

		Current (mA)			Isolation resistance (Ω/V)	
		$I(A) \times 1000$		Ratio DC/AC	$1/(I(A))$	
		AC	DC		AC	DC
Boundary values	Line a	0.5	2	4.0	2000	500
	Line b	5	26	5.2	200	38
Isolation threshold	log-log	2	9.37	4.68	500	107
	lin-lin	2	10.00	5.0	500	100

96. The 100 Ω/V would be a good choice for a DC isolation value for harmonization reasons, because it is specified in the relevant SAE and ISO documents, as well as Japanese and UN Regulation.

(a) *Rationale for Protection against Water Effects*

97. Environmental effects such as exposure to water may deteriorate the isolation resistance of high voltage bus. This may first lead to an electric system degradation and eventually lead to an unsafe electrical system and electrocution of vehicle occupants, operators (during charging) or third parties/passers-by.

98. To maintain minimum isolation resistance is the essential concept of electrical safety under single failure conditions. However, the electric shock may occur only when both an isolation loss and an additional failure occurs at the same time (i.e. isolation loss itself does not cause an electric shock as long as other measures "protection against direct contact" and "protection against indirect contact" are maintained). In order to prevent an electric shock in the event of secondary failure following the isolation loss, two approaches are considered effective, (a) ensure the robustness of electrical isolation under relevant environmental conditions, or (b) urge the user to repair the vehicle when the minimum isolation resistance is not maintained. However, it should be noted that the existence of the warning function is not, per se, a safety prevention system and an interruption of the high voltage system may be necessary e.g. during certain charging conditions.

99. Washing and driving through shallow standing water are considered as the examples of usual conditions in normal vehicle operation, and in principle, all vehicles shall maintain isolation resistance after being exposed to water under such environmental conditions. Two test procedures for protection against water effects are foreseen with a view to evaluate the

robustness of electrical isolation under such environmental conditions, in particular, for vehicles with a poor electrical and vehicle design.

100. Advanced electrical and vehicle design and technological solutions, such as insulation that shields the electrical equipment and other devices which might be in a potential contact with a high voltage bus and the electrical chassis, including fully encapsulated systems, can increase the odds of maintaining isolation resistance after exposure to water. In such a case, conducting a vehicle level test may not be necessary, as the high voltage system of the vehicle maintains electrical isolation after water exposure. Evidence demonstrating how the electrical design or components of the vehicle located outside the passenger compartment or externally attached, after water exposure remain safe is sufficient.

101. Alternatively, vehicles equipped with isolation monitoring system can also contribute to the safety of vehicle occupants in case isolation resistance has been compromised, e.g. after exposure to water. On-board isolation resistance monitoring system monitors the isolation resistance of the vehicle's high voltage bus and provides a warning to the driver if the minimum isolation resistance is not maintained.

102. With the warning, the user will take the vehicle for repair and therefore the risk of secondary failure that may cause electrical shock will be mitigated. However the warning alone may not be considered sufficient, in particular for those individuals who do not have the possibility to observe/or are aware of the warning signal (e.g. passers-by, first responders).

103. The confirmation method for the functions of the on-board isolation resistance monitoring system is based on FMVSS305, which is the same concept as that of UN GTR No.13.

7. Rationale for REESS requirements

(a) Definitions of terms related to REESS requirements and its applicability:

104. The following terms are used for setting the pass-fail criteria of REESS requirements:

- (a) Electrolyte leakage (3.16.);
- (b) Venting (3.50.);
- (c) Rupture (3.39.);
- (d) Fire (3.22.);
- (e) Explosion (3.19.).

105. These terminologies, in general, correspond to the relevant industry standards and UN Transport of Dangerous Goods, Manual of Tests and Criteria, paragraph 38.3.

106. Applicability of these criteria is considered based on the vehicle status intended for each test scenario; e.g. under normal condition, in case of an accident or exposure to fire, etc. For the tests simulating normal condition (simulated by in-use test conditions), all of five criteria shall be met, while the tests simulating an accident or unusual circumstances, only the more severe events such as fire or explosion are applied as the criteria.

107. In addition, minimum isolation resistance of 100 Ω/V is also required for the tests simulating normal driving conditions, considering the fact that all existing REESS provide DC current. For REESS post-crash safety (component-based tests) under paragraph 5.5.2.1. of this UN GTR, either the minimum isolation resistance requirements or the protection degree IPXXB shall be fulfilled, due to the fact that loss of isolation resistance is not an

immediate hazardous effect if one cannot come in parallel contact with a second hazardous potential (solved by IPXXB requirement).

(b) *Installation of REESS (paragraph 5.3.1.)*

108. Paragraph 5.3.1. provides the requirements with respect to the REESS installed on the vehicle, where the vehicle manufacturer may choose either paragraph 5.3.1.1. (REESS specific to certain vehicle) or paragraph 5.3.2.2. (REESS designed for various types of vehicles) for compliance. In case of REESS for various vehicles, its installation to each type of vehicles shall be in accordance with the instruction by the manufacturer of the REESS because certain parameters for the REESS component tests may be determined assuming the installation condition on the vehicle.

(c) *Rationale for warning requirements (paragraphs 5.3.2. to 5.3.4.)*

109. Driver warning due to failure of vehicle controls that manage safe operation of REESS: the vehicle controls manage various battery operations, some of which are safety critical. There are multiple fault scenarios that could trigger a vehicle control to take corrective action. This UN GTR provides REESS safety requirements for various REESS safety scenarios. These REESS safety requirements assume that the management system of the REESS is properly functioning. For example, the requirements for overcharge, over-discharge, over temperature, and overcurrent assess the functionality of the vehicle controls that manage REESS operations. Therefore, in order to ensure the safety in a real world condition, it is important to ensure that the vehicle will not be continuously used under the failure condition of the vehicle controls that manage REESS safe operations. Consequently, the driver should be provided with a warning when these vehicle controls are not functional. This requirement applies when the driver is seated in the vehicle and switched to the active driving possible mode.

110. Since this UN GTR specifies requirements to evaluate the proper functioning of vehicle controls that manage REESS safe operation in overcharge, over-discharge, over temperature and overcurrent conditions, the warning requirement only addresses the condition of operational failure of vehicle controls that manage safe operation of REESS.

111. Due to the complexity and varied designs of vehicle controls that manage REESS safe operation, no single test procedure could be developed that would fully evaluate whether a warning tell-tale turns on in the event of operational failure of vehicle controls. Therefore, manufacturers are required to provide documentation demonstrating that a warning to the driver will be provided in the event of operational failure of one or more aspects of vehicle controls that manage REESS safe operation.

112. Driver warning due to a thermal event within the REESS: Real world data indicates that a thermal event within a battery pack is a major safety critical event associated with electric powered vehicles that can result in smoke, fire and/or explosion that can pose a safety hazard to occupants in the vehicle. A thermal event is when the temperature within the battery pack is significantly higher than the maximum operating temperature (even at reduced power). A warning should be provided to the driver in the event of a significant thermal event within the battery pack. In order to avoid design restrictive requirements, manufacturers are required to provide documentation on the parameters that trigger the warning and a description of the system for triggering the warning.

113. Driver warning to notify low energy content of REESS: The purpose of this warning is to notify the driver that the remaining stored energy in the REESS would only permit the vehicle to be driven a short distance. This warning would alert the driver to charge the REESS as soon as possible, so that the EV would not be stranded on the road.

114. At the indicated low state of charge specified by the vehicle manufacturer, the following performance is generally expected:

- (a) It is possible to move the vehicle out of traffic using its own propulsion system;
- (b) A minimum energy reserve is available for the lighting system as required by National and/or International Standards or regulations, when there is no independent energy storage for the auxiliary electrical systems.

115. As the traffic conditions and layouts of charging stations vary in different countries, it is difficult and unnecessary to set a mandatory limit of this "low energy". Manufacturers could specify the limit value of REESS remaining energy themselves according to the certain road conditions and performance of their product. It is also suggested that the remainder range (including the driving condition) could be introduced to the driver in the owner's manual.

116. Currently, the most of conventional vehicles are equipped with a low fuel warning. When there is little fuel left, the warning is given to the driver to refuel as soon as possible. Traditionally, manufacturers have defined this threshold value on their own.

117. Although there are no recorded accidents for electric battery vehicles running out of energy, it should be noted that in some countries, this warning is mandatory. It is beneficial to regulate the necessary design for vehicle manufacturers at the current technical development level. Due to the complexity of the vehicle warning, only basic requirements can be proposed for regulatory purposes, but the inclusion of such requirements will eliminate vehicle designs without a REESS low energy warning.

(d) *Adjustment of State of Charge*

118. It was observed by the technical experts that in certain circumstances the severity of the REESS reaction to specified test requirements may be influenced by the REESS SOC. As a result, it was felt that the SOC specification was an important aspect to include in regulatory requirements. This is especially important for tests involving potential thermal runaway/propagation.

119. Supporting research and analysis on the safety related behaviour of Li-ion cells is provided by Balakrishnan et al.⁶ Wang et al⁷ provides detailed information regarding SOC effects on the chemical reactions during thermal runaways for typical Lithium ion cell chemistries.

120. Most research publications refer to cell level research, while for automotive applications the behaviour of larger cell packs is what is relevant. While such data is not widely available, there is a lack of evidence to indicate that behaviour at pack level would differ significantly with respect to the trends observed at cell level.

121. At the cell level, researchers found⁸ that at higher SOC levels the thermal runaway onset temperature is reduced. The characteristics of different cell chemistries (cathode materials), lithium cobalt oxide (LCO), lithium nickel manganese cobalt oxide (NMC) and lithium iron phosphate (LFP) were compared⁹ and a tendency towards lower onset

⁶ Balakrishnan et al, "Safety mechanisms in lithium-ion batteries", Journal of Power Sources 155 (2006) 401-414

⁷ Wang et al, "Thermal runaway caused fire and explosion of lithium ion battery", Journal of Power Sources 208 (2012) 210-224

⁸ Roth, E.P. "Final Report to NASAJSC: Thermal Abuse Performance of MOLI, Panasonic and Sanyo 18650 Li-Ion Cells", Sandia Report: SAND2004-6721, March 2005

⁹ Liu, X.; Wu, Z.; Stolarov, S.I.; Denlinger, M.; Alvaro, M.; Snyder, K.: "Heat release during thermally-induced failure of a lithium ion battery: Impact of cathode composition", Fire Safety Journal 85 (2016), 10-22

temperatures (for safety venting and thermal runaway) was observed as SOC increased (with the exception that LFP cells did not experience thermal runaway)¹⁰. Research further indicates¹¹ that based on cell level testing, the total amount of released heat increases by approximately 11 per cent for both LFP and NMC based cells when increasing SOC from 25 per cent to 100 per cent.

122. While technical experts were not able to verify whether the rate of the energy release or the total energy released is the more critical parameter related to a propagating thermal runaway and for the vehicle-level risk, lower SOC-dependent onset temperatures were determined to be significant parameters influencing the onset temperature for cell thermal runaway.

123. For typical vehicle applications, it should be noted that Li-ion batteries are not using their full physical capacity range, but only a limited window, primarily to ensure reliability, improve degradation and achieve high charging cycle numbers. The size of such windows depend on the specific Li-ion battery technologies used and the type of applications (typically larger windows for high energy applications, smaller ones for high power applications). As a result, the safety related effects of SOC in real vehicle applications will be much more moderate than for typical laboratory investigations exploiting the full physical SOC ranges.

124. In this UN GTR it was felt that specifying the SOC as high as possible within the considered constraints and technical capabilities would provide the highest margin of safety. Constraints on the specification of SOC are the availability of external charging ports for the Tested-Device, capabilities are limited by temperature related capacity variations¹², manufacturing tolerances¹³ and inaccuracies of capacity measurement, which according to JRC can amount to 2 per cent derived from each 1 per cent tolerance for current and voltage measurement. Further references provided by JRC confirm the variation of capacity as up to 10 per cent for a thermal window between +10 °C and +30 °C as defined for the charging process here.

125. The UN Regulation No. 100-02 defines the ambient temperature range for adjusting SOC and testing at 20 ± 10 °C. In the case of vehicle-based test, BMS (Battery Management System) controls the SOC to achieve the highest SOC in a stable manner under such a moderate temperature range. On the other hand, in case of component-based test, BMS may not be installed on the tested-device resulting in potential fluctuation of the adjusted SOC depending on the ambient temperature. Accordingly, it was recommended to tighten the ambient temperature range for the component-based test. Further, the target temperature was reviewed taking into account the ambient temperature conditions of other safety standards or regulations and the limitations of existing testing facilities. As a conclusion, the informal working group decided to specify the ambient temperature at 22 ± 5 °C for component based and 20 ± 10 °C for vehicle based testing.

¹⁰ Orendorff, C.J.; Lamb, J.; Steele, L.A.M.; Spangler, S.W.; Langendorf, J.L.: "Battery Safety Testing", 2015 Energy Storage Annual Merit Review, Sandia National Laboratories

¹¹ Sturk, A.; Hoffmann, L.; Ahlberg Tidblad, A.: "Fire Tests on E-vehicle Battery Cells and Packs", Traffic Injury Prevention (2015), Taylor & Francis

¹² Johnson et al, "Temperature-Dependent Battery Models for High-Power Lithium-Ion Batteries", 17th Annual Electric Vehicle Symposium, Montreal, Canada October 15-18, 2000

¹³ Kennedy, B. et al, "Modelling the impact of variations in electrode manufacturing on lithium-ion battery modules", Journal of Power Sources, 213 (2012), 391-401

126. Accounting for above-mentioned constraints, i.e. charging opportunities, the SOC setting is split into three procedures:

- (a) For a test on vehicle level with availability of an external charging port the procedure is deemed straight forward to normally charge the REESS until the vehicle's internal control device automatically stops the charging process. In case of several charging methods (e.g. normal or fast charging), the manufacturer must advise on the method that delivers the higher SOC;
- (b) For a vehicle level test with a hybrid vehicle without external charge port the adjustment of the SOC is generally not directly possible. The SOC level is adjusted via complex internal algorithms by the vehicle's on-board control system. Overriding such systems to enforce high SOC levels is not appropriate and may risk damage to the test object and/or operator health and safety. Furthermore, such conditions are not representative of the state of the vehicle in actual operation. HEVs generally try to maintain their SOC around a mid-level in order to provide immediate capacity for power delivery as well as for recuperation. Extreme SOC levels are by nature transient events for such systems. As a consequence, no discrete SOC has been defined for such applications. Given the diversity of vehicle system technologies and architectures and to ensure that the highest practical SOC is obtained, the test procedure specifies that the testing services/authorities consult the vehicle manufacture on SOC measurement and setting procedures;
- (c) For a test with a REESS separate from the vehicle, a distinction has been made as to whether the DUT does or does not contain the original charge control system. In the former case, it is assumed that the embedded charge control system will terminate the charging when the full SOC is achieved. For the latter case, the manufacturer must define the normal operating SOC range and the appropriate charging procedure. Considering above mentioned arguments it was seen as necessary to allow for some tolerance with regard to fixing the SOC at the beginning of tests, requiring minimum 95 per cent of the "normal operating SOC range" as defined by the manufacturer.

127. It was discussed within the informal working group that certain chemistries do not allow for direct measurement of the SOC via external Open Circuit Voltage (OCV), because their OCV/SOC-curves are principally flat within the normal operating SOC range. In such cases, and where saturation and load hysteresis reasons are prevalent, the charge level has to be controlled via the accumulated current fed through the external charging system while conducting a standard cycle (see para. 6.2.1).

128. Often the charging and SOC setting may be carried out by the manufacturer before shipping the DUT to the test laboratory. Depending on waiting duration and due to parasitic currents or consumption through internal control systems, discharging may occur before the actual test. As a potential measure to preserve the initial SOC the informal working group discussed limiting the period between the final setting of the SOC and the actual start of the test to 48 hours. While such limit would have been practicable, though restrictive, within a type approval environment, it was not viewed as appropriate for self-certification systems. Accounting for potentially unavoidable loss of charge within the shipping and preparation period, for systems with direct charging possibilities, it was seen as acceptable and of negligible influence to allow for a relative loss of charge of 5 per cent related to the SOC at the end of the charging process. For systems without external charging possibility (like HEVs) the maximum allowed discharge is 10 per cent, accounting for the losses required to operate the internal control systems, or to feed consumers of the vehicles' low voltage systems. The laboratory staff or technical service is required to take care that any unnecessary energy consumption from the REESS is avoided.

129. Direct verification of the final SOC before test may again be subject to above-mentioned complexity. As a result, vehicle manufacturers may use alternative assessment methods, like demonstrating compliance to respective performance standards (see EVSTF-07-05) and confirmation of appropriate actions to preserve available charges.

8. REESS in-use requirements

(a) *Vibration (paragraphs 5.4.2. and 6.2.2. of this UN GTR):*

130. The purpose of this test is to verify the safety performance of the REESS under a vibration environment which the REESS would likely experience during the normal operation of the vehicle.

131. A vibration load spectrum for lithium cells and batteries including lithium ion cells/batteries and lithium polymer cells/batteries is already defined as a type approval test procedure of dangerous goods of class 9 in the Recommendations on the Transport of Dangerous Goods, Manual of Tests and Criteria, paragraph 38.3.4.3. (Test T3: Vibration), with an amplitude sweep ranging from 7 Hz to 200 Hz.

132. As Recommendations on the Transport of Dangerous Goods, Manual of Tests and Criteria sign-off may often also be mandatory for types of REESS (such as lithium metal batteries, lithium ion batteries and lithium polymer batteries) subject to this regulation, having the opportunity to cover this test with test T3, is seen as an efficient approach.

133. However the load curve per Test T3 is assessed as too severe for automotive applications. Despite the recent lowering of the high frequency amplitude in Test T3 from 8g to 2g for "large batteries" with masses more than 12 kg, even this amplitude is still not considered representative for the typical sizes of REESS in vehicles, with a mass of 200 kg or more. Particularly the height of the amplitudes above 18 Hz is seen as unrealistic and does not correlate to the loads seen in road vehicles (except for hypothetical cases of REESS mounted close to or onto a combustion engine). Due to the stiffness of vehicle bodies in relation to the module weight frequencies, frequencies higher than 18Hz cannot be transmitted at significant energy levels.

134. This UN GTR, therefore, uses the same frequency vertices as Test T3, albeit those for smaller cells, but lowers the load curve above 18Hz and truncates it at 50Hz.

Figure 13

Comparison of proposed with Test T3 load curve

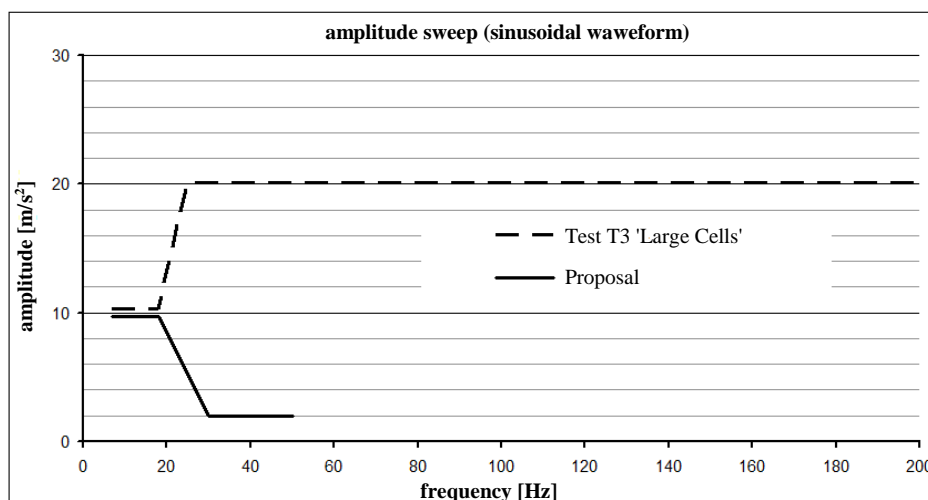

135. The test duration is also aligned with Test T3, requiring 12 transitions from the minimum to the maximum frequency and back within 15 min., resulting in a total test duration of 3 hours.

136. While Test T3 requires the test to be performed in all three spatial directions, in vehicle applications this load occurs in the vertical direction only, while the longitudinal and lateral vehicle dynamic loads are significantly lower. The vibration test therefore needs to be performed in the vertical installation direction only. When utilizing this option, the orientation of the REESS in the vehicle must be restricted accordingly; this information shall be communicated to the regulating entity by the vehicle manufacturer. The administrative procedures to ensure such a communication will be specified by the regulating Contracting Party.

137. In many cases, the vehicle manufacturer assesses the vehicle's durability with full vehicle simulation, either by running a rough road test track or by simulating the lifetime fatigue on a 4-poster vibration rig. These methods provide a vehicle specific assessment of the durability of all vehicle components and should be accepted in this context.

138. To finalize the certification of the REESS, a standard cycle has to be performed, to verify that the mechanical loads have not had any negative effect on the electrical function.

(b) *Thermal Shock and Cycling (paragraphs 5.4.3. and 6.2.3. of this UN GTR)*

139. In a real world application, subsystems like REESS are subjected to changes in environmental temperature, some of which may be rapid.

140. Such temperature changes can result in significant thermal expansion of components. Since different materials with different Coefficients of Thermal Expansion (CTE) are used, this can lead to different levels of expansion of the components potentially causing mechanical stress.

141. A REESS would likely experience several changes in environmental temperature or rapid changes in environmental temperature during its life. The mechanical stress and/or different material expansions caused by this temperature changes may potentially influence REESS integrity or internal electrical connections.

142. Therefore, in order to ensure safety, it is important to test the robustness of the REESS against temperature shocks and to perform a standard cycle to test the functionality after test.

143. The Thermal Shock and Cycling Test shall verify that the REESS is immune to thermal fatigue and contact degradation that is caused by temperature changes and possible mismatching of the CTE of materials.

144. Similar tests are currently used for validation of electrical components and subsystems. Also, a thermal shock and cycling test (Test T2: Thermal test) is part of the test sequence of transportation tests according to paragraph 38.3. of Recommendation on the Transport of Dangerous Goods, Manual of Tests and Criteria.

145. As this Recommendation sign-off may often also be mandatory for types of REESS (such as lithium metal batteries, lithium ion batteries and lithium polymer batteries) subject to this regulation, having the opportunity to cover this test with Test T2: Thermal test, of this Recommendation, is seen as an efficient approach, while the higher extreme temperature is determined by referring the IEEE Standard 1725 (2006), Annex E, "Temperature rise on each position in the car under clear weather".

146. The test requirements and boundary conditions are transferred from the UN Regulation No.100, 02 series of amendments.

147. Minus 40 °C is generally agreed as the lowest temperature to be considered in automotive applications (e.g. UN GTR No.13). The aim of the temperature shock and cycling test is to ensure that the design of the REESS is able to bear the sudden temperature shocks of real life. Considering this aim it was agreed during the discussion in the informal group of experts at the 02 series amendment to UN Regulation No.100, that a sudden temperature difference of 100 °C is more than what would be observed in real life and therefore sufficient regarding the aim of the test procedure. It could be shown by applying durability tests in a mid-European environment that during operation the maximum temperature of the battery will not exceed 60 °C (see Figure 14).

Figure 14
Occurrence of battery temperature

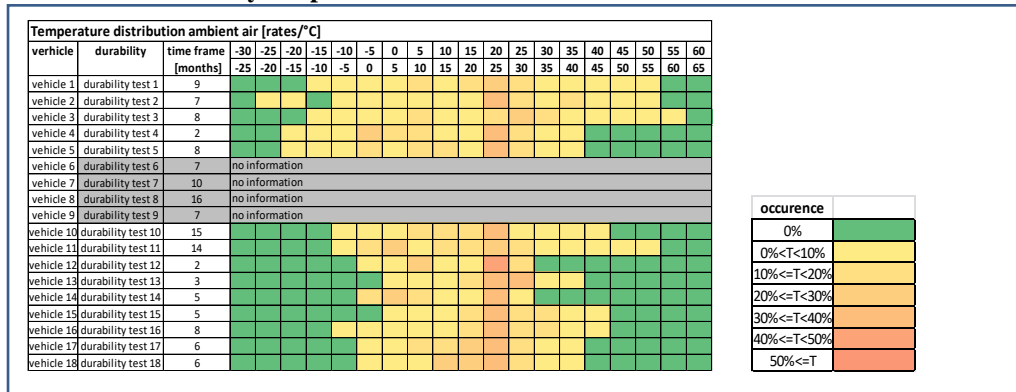

148. According to these results, the real life scenario with highest temperature difference is parking a vehicle outside (maybe overnight) at -40 °C, starting the vehicle and heating up the battery during operation to the highest temperature of 60 °C.

(c) *Fire resistance (paragraphs 5.4.4. and 6.2.4. of this UN GTR)*

149. The purpose of the test is to ensure that occupants have adequate time to evacuate the vehicle in case of exposure to fire from outside of the vehicle due to e.g. a fuel spill from a vehicle (either the vehicle itself or a nearby vehicle). Furthermore, the level of specification is equivalent to the minimum safety levels specified for existing liquid fuelled vehicles and is similar to the requirements for plastic fuel tanks in UN Regulation No.34. While specific data regarding evacuation time requirements are not available, real-world experience with the sufficiency of UN Regulation No. 34 indicates that the regulatory requirements are at a sufficient level of performance to address the safety aspects of external fire exposure.

150. The test is required for REESS installed in a vehicle at a height lower than 1.5 m above the ground. The 1.5 m limit is deemed appropriate since the impact of a fire on a REESS installed at or above this height in a vehicle is considered insignificant given the inherent presence of considerable vehicle structure that acts to shield the REESS from fuel pool fire exposure when the REESS is mounted at and above that height.

151. The requirement for plastic fuel tanks in UN Regulation No. 34 specifies that it passes three repetitions of the same test (i.e. 60s preheat + 60s direct exposure to flame + 60s indirect exposure to flame). As evidenced by the high similarity of results for these tests (see multiple UN Regulation No. 34 tests on the Figure 15) the number of tests specified in paragraphs 5.4.4. and 6.2.4. have been reduced from three to one. In order to compensate for potential variations in fire exposure, the direct exposure phase of the test has been increased by 10s. The 10s additional time was determined based on experimental data presented in Figure 15 below which illustrates temperatures measured on a simulated vehicle during fire exposure from 3 tests of UN Regulation No. 34 (i.e. 60 s preheat + 60 s

direct exposure to flame + 60 s indirect exposure to flame) and modified versions of the test of UN Regulation No. 34 (e.g. 90 s direct exposure, no preheat period and 60 s direct exposure, no preheat period). These curves also confirm that the preheating period does not influence the temperature rise curves for the device under test and thus have been removed from the test procedures contained in this UN GTR.

Figure 15
Mean of temperature readings on a vehicle Mock-up during different "Regulation No. 34" exposures

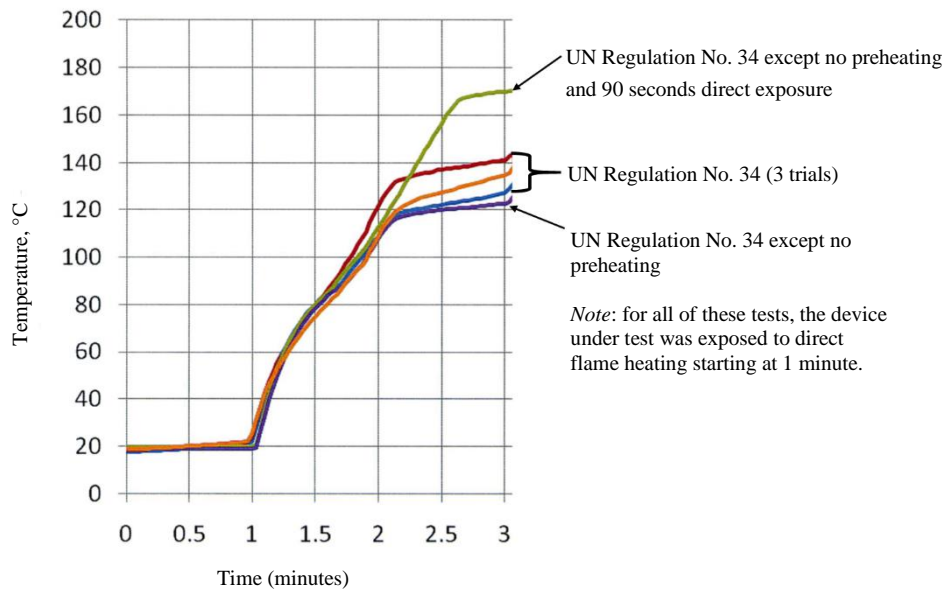

152. A fire resistance test procedure on a component level is also provided. This test procedure is similar to the procedure for the vehicle level test. Since this procedure should be valid for all possible placements of the REESS in a vehicle, the height at which the REESS is placed during the test is determined to represent the worst case. Experiments were conducted in which the temperature as a function of height was measured above the fuel surface for various pool sizes, some are presented in Figures 16 and 17 below. Based on the results of these tests, a height above the fuel surface of 50 cm was selected for component testing.

Figure 16.
Temperature readings at different heights above a 2.2 m² pool fire

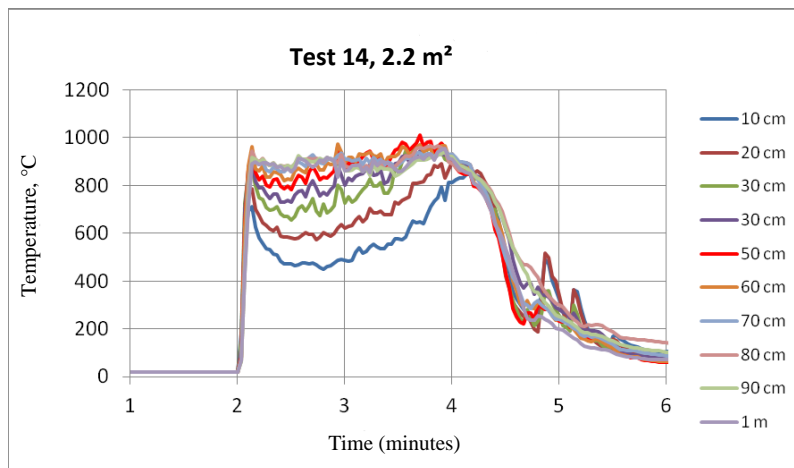
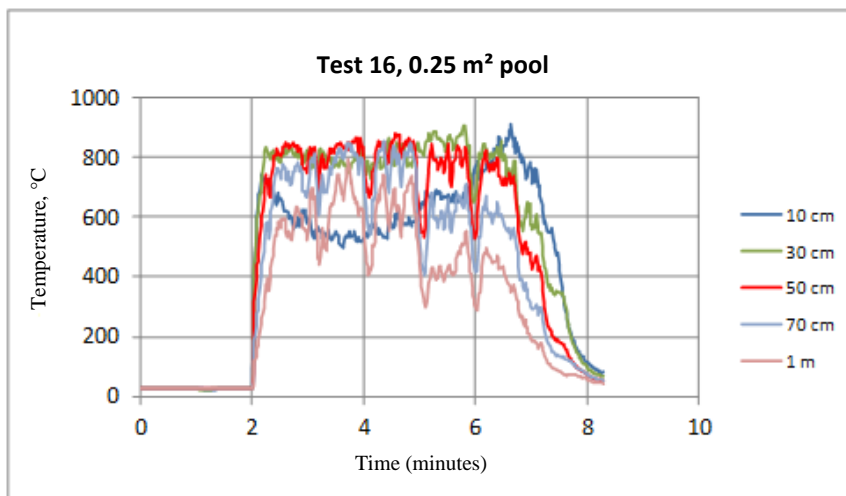

Figure 17
Temperature readings at different heights above a 0.25 m² pool fire



153. A significant difference between fuel tanks and REESS is that REESS can produce heat on their own, possibly developing a thermal runaway. Therefore, the test procedure differs from the procedure described in UN Regulation No. 34. No external cooling or extinguishment of the tested device is conducted as is done in the fuel tank test to facilitate the search for leaks. Instead, the tested device is observed for at least 3 hours to confirm that the temperature decreases and no dangerous processes resulting in an explosion have been initiated during the exposure.

154. Alternative test procedure using Liquefied Petroleum Gas (LPG) burner (paragraph 6.2.4.3.4.): it is inherently difficult to control the behaviour and conditions of the flame in gasoline pool fire tests due to its turbulent nature. To improve flame controllability and reproducibility, Korea Automobile Testing and Research Institute (KATRI) have researched and proposed (EVS-02-07e) an LPG burner fire test for REESS (see illustration of burner configuration in Figure 18). The test method is similar to UN GTR No.13 (Hydrogen container in hydrogen fuel cell vehicle). The LPG burner specified can control the height and temperature of the flame by regulating the mass flow rate of LPG supplied. As a result, fire tests performed with an LPG burner have the advantage of being more controllable and hence repeatable/reproducible.

Figure 18
Illustration of KATRI LPG Burner

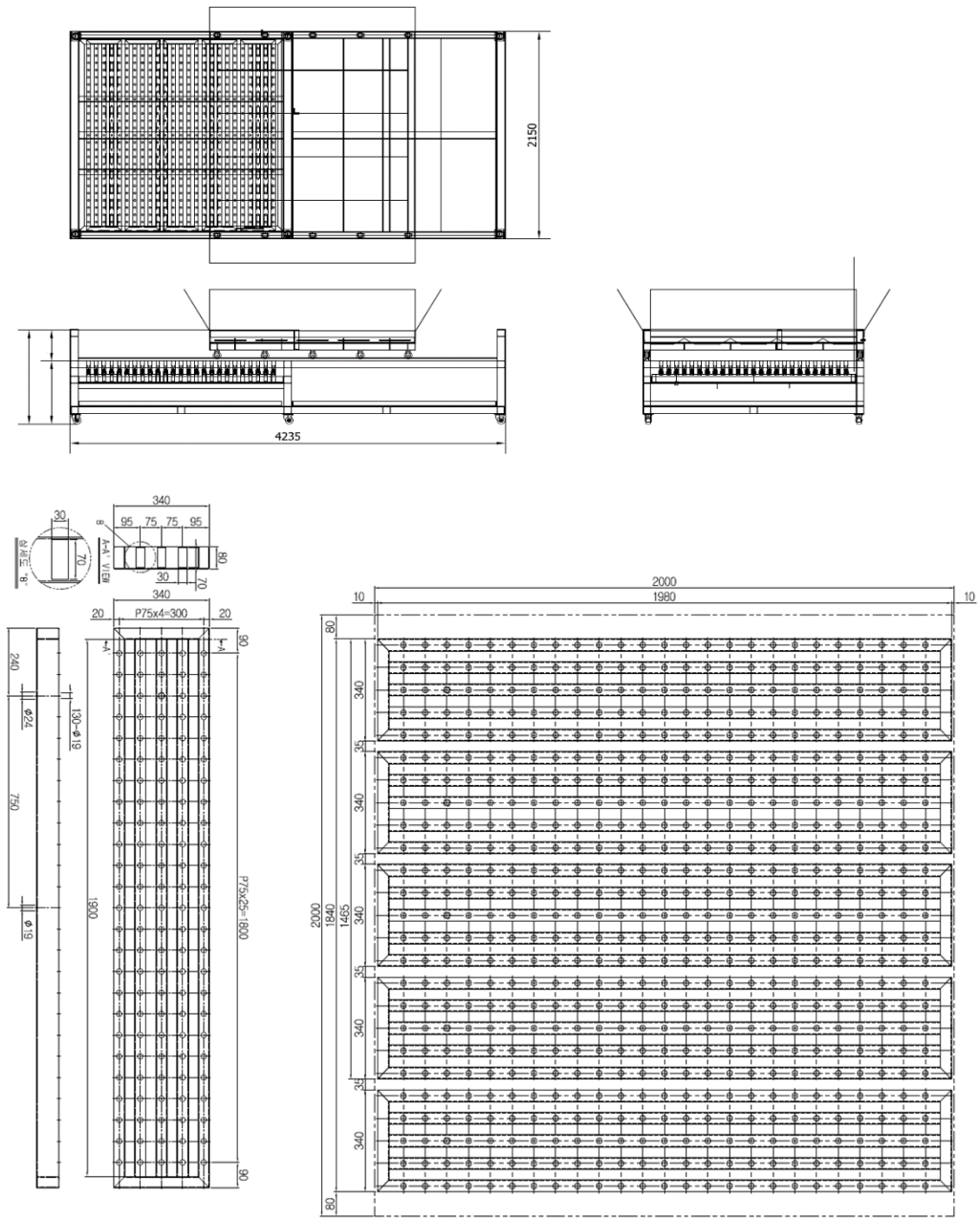

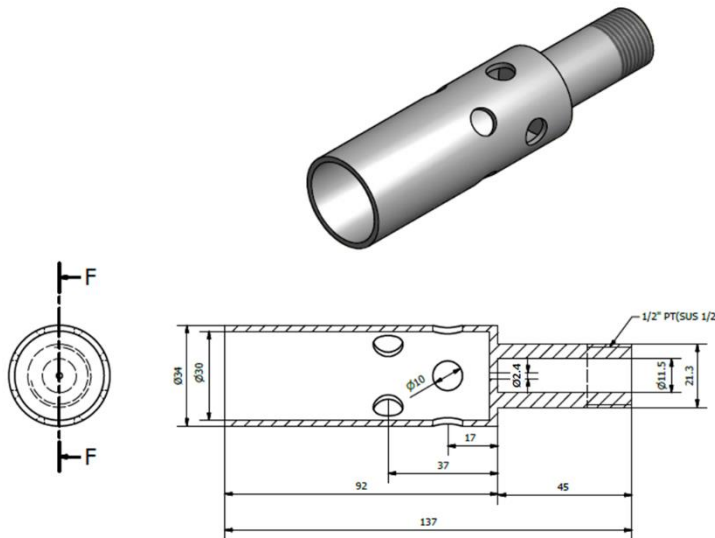

155. Research was conducted to develop LPG burner specifications to be equivalent in terms of flame temperature and heat flux to typical gasoline pool fires.

156. Experts noted that the emissivity of fuel increases with increasing amount of carbon and higher luminous flame (Figure 19). As a result, the heat flux can differ depending on the fuel even if the flame temperature is equivalent. Based on testing and analysis conducted, it was determined that the specifications developed for the LPG burner meet the necessary criteria for equivalence. At this time, appropriate specifications and analysis on other potential fuel types have not been conducted and as a result, they are not included in this UN GTR.

Figure 19
Emissivity of Different Fuel Flames¹⁴

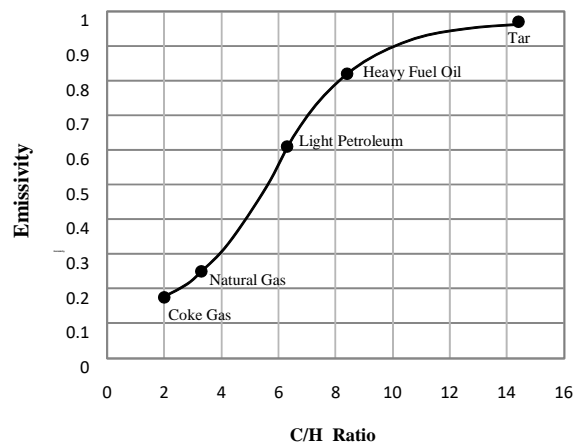

157. Even if the same fuel is used and the relative position of the object that is exposed to the flame is the same, the heat flux cannot be the same unless the shape of flame is also equivalent. Therefore, to reproduce the same heat flux the shape of flame should be appropriately controlled.

¹⁴ J. Stepanke, Industriell Wärmetechnik. Vulkan Verlag, Essen. Deutschland. 1977

158. In order to verify the equivalency between LPG burner test (paragraph 6.2.4.3.4) and gasoline pool fire test (paragraph 6.2.4.3.3), the temperature and heat flux of the flame were measured under the same conditions without a Tested-Device (i.e., REESS) (EVSTF-07-29e). The temperature was measured under the Tested-Device at five positions 25 ± 10 mm below the Tested-Device's external surface. The heat flux was measured at a certain distance from the flame and central area of the Tested-Device's position.

159. Measurements of flame temperature and heat flux of an LPG burner fire are shown in Figure 20. During the test, the mass flow rate of LPG was increased every 60 s by 25 kg/h between 175 kg/h and 275 kg/h. Measurements of flame temperature and heat flux of a gasoline pool fire during phases A, B and C (see paragraph 6.2.4.3.3. Gasoline pool fire test), measured in accordance with paragraph 6.2.4.3.4.4. are shown in Figure 21.

160. The measured heat flux of an LPG burner fire is around 30-40 kW/m² and is almost constant at each mass flow rate. As mass flow rate increases, the heat flux increases almost proportionally. The heat flux of a gasoline pool fire is around 25-50 kW/m².

Figure 20
Flame temperature and heat flux of an LPG burner fire with increasing LPG mass flow rate (without Tested-Device)

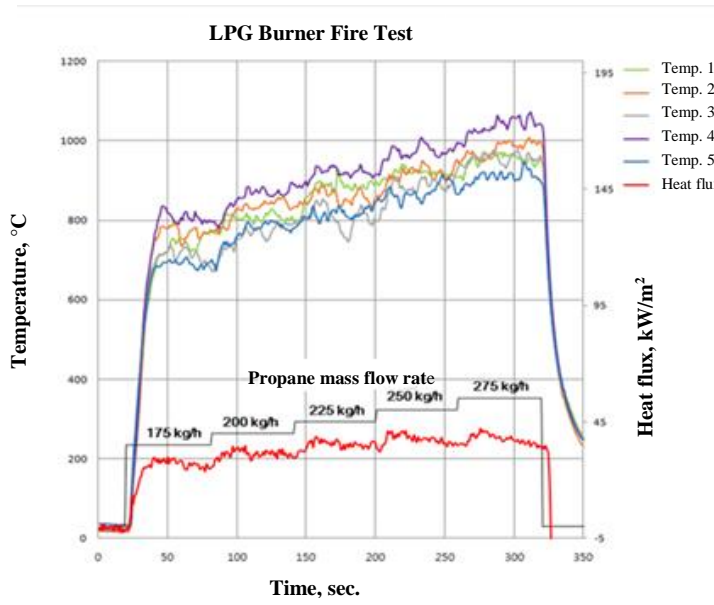
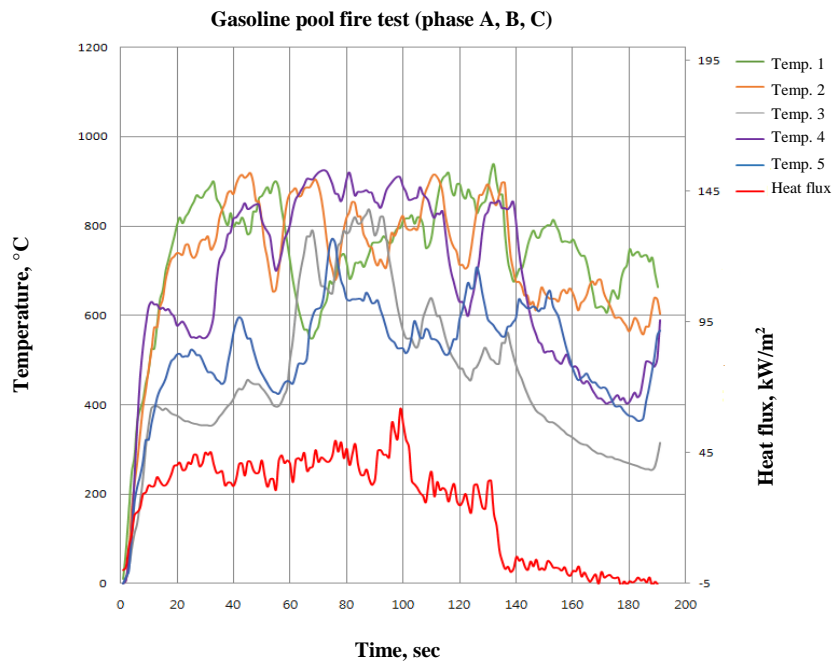

Figure 21
Flame temperature and heat flux of gasoline pool fire (without Tested-Device)



161. Table 3 compares the integral heat flux at each test condition. For the LPG burner test (paragraph 6.2.4.3.4. of this UN GTR), the integral heat flux during the direct flame exposure time (i.e. the time to reach 800 °C and 2 more minutes) at each LPG mass flow rate is shown in Table 3 and compared with the integral heat flux during 130 s (for phases B and C) for the gasoline pool fire test (paragraph 6.2.4.3.3. of this UN GTR).

162. Test results revealed that the integral heat fluxes in the gasoline pool fire and LPG burner fire tests were almost equivalent at an LPG mass flow rate of 200 kg/h. For this reason, an LPG mass flow rate of 200 kg/h is considered appropriate during the test.

Table 3

Comparison of heat flux between LPG burner and gasoline pool fire

<i>LPG burner</i>		<i>Gasoline pool fire</i>	
Fuel (Mass flow rate)	Integral Heat flux	Fuel	Integral Heat flux
LPG (175kg/h)	4 181	Gasoline	4 460
LPG (200kg/h)	4 450		
LPG (225kg/h)	4 945		

163. The temperature of an LPG burner fire (mass flow rate: 200kg/h) and a gasoline pool fire with Tested-Device (REESS mock-up) were also compared.

Figure 22
Test scene photographs and temperature measurements of a gasoline pool fire and an LPG burner fire

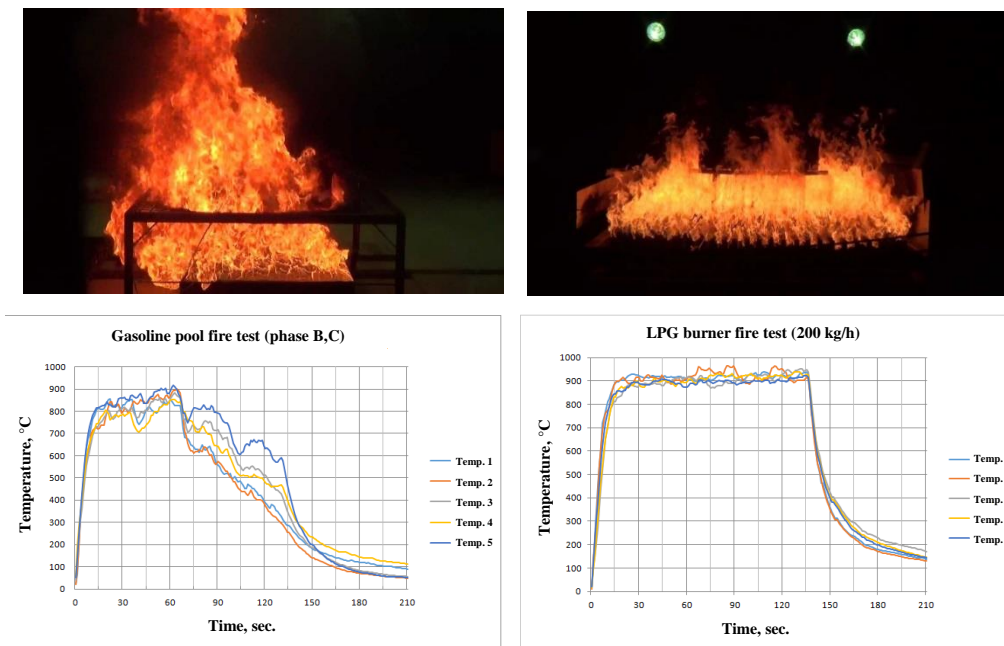

164. Figure 22 shows that the temperature is 850-950 °C in an LPG burner fire with a Tested-Device at an LPG mass flow rate of 200 kg/h, which is higher than the gasoline pool fire temperature. In the gasoline pool fire test the temperature is 700-900 °C during the direct flame exposure phase (phase B) and 300-800 °C during the indirect flame exposure phase (phase C). The temperature deviation observed in the LPG burner test is much smaller than that of the Gasoline pool fire test.

165. Since the temperatures were not found to be exactly equivalent, research was conducted with different examples of potential Tested-Devices (i.e. various sizes of mocked up REESS) to verify whether the temperature differences would result in significantly different results and whether adjustments to the temperature sensor locations relative to the Tested-Device would make the results more equivalent (EVSTF-08-54e).

166. When temperatures are measured, the average value of the five sensors is used to determine the temperature condition to compensate for temperature deviations due to the Tested-Device's structure or transient temperature variations. The flame temperature should be measured continuously and an average temperature is calculated at least every second for the duration of the fire exposure.

167. Temperature sensors should be located at adequate places which can represent the entire area of the Tested-Device's bottom. At least one sensor should be located at the centre of the Tested-Device and four sensors located near the edge of the Tested-Device with equal distance in order to make sure that the Tested-Device is exposed to a uniform flame over the entire bottom area (EVSTF-08-54e).

168. When determining a distance of 50mm below an irregularly shaped Tested-Device (e.g. a tunnel shape), this distance is determined from the lowest point of the Tested-Device in the orientation intended for the vehicle. As a result, all temperature sensors should be installed at a distance of 50 ± 10 mm below the lowest point of the Tested-Device's external surface and in a single plane.

169. When the Tested-Device's bottom has significant surface geometry irregularities (e.g. deep recesses, etc.) there may be insufficient airflow in that location which can result in lower temperatures. For such cases, this location should be avoided when placing the temperature measurement sensors.

(d) *External short circuit protection (paragraphs 5.4.5. and 6.2.5. of this UN GTR)*

170. This test is to verify the performance of the vehicle controls (protection measure) against a short circuit occurring external of the REESS. If certain protection device (e.g. fuse, contactor, etc.) exists in the REESS, the functionality of such device will be evaluated and if no such device exists, the robustness of the REESS against short circuit will be evaluated. The test procedure has been developed based on existing standards and other technical references. The resistance of the connection (5 mΩ or less) is taken from SAE J2464 (Surface vehicle recommended practice, Electric and Hybrid Electric Vehicle Rechargeable Energy Storage System (RESS) Safety and Abuse Testing, November, 2009) as specified for pack hard short. The value of the short circuit resistance may need to be reviewed in the future taking account for development of related regulations or standards for soft short conditions.

171. This test procedure does not address the short circuit event inside the casing (battery pack enclosure) of REESS, since the occurrence of such short circuit events will be assessed by the other tests such as vibration, thermal shock and cycling, and mechanical impact.

172. The test is conducted under ambient temperature conditions and with SOC at the maximum level (since higher SOC levels could result in higher likelihood of thermal runaway/propagation in the event of failure of controls). The short circuit test may be conducted with a complete REESS or REESS subsystem(s) for which the REESS subsystem performance in the test represents that of the complete REESS. The test may also be conducted at the vehicle level using breakout harness to apply the short circuit.

173. After the short circuit test is terminated, a standard charge/discharge cycle is conducted if permitted by the Test-Device (vehicle, REESS, or REESS subsystem(s)). An additional performance criterion for the short circuit test is that the vehicle or REESS controls terminate the short circuit current or the temperature measured on the casing of the REESS is stabilized for 2 hours after the short circuit is introduced. While current REESS designs have short circuit protection controls that terminate the short circuit current, there may be future REESS designs that may not need such controls and so evaluation of safety is based on the stability of REESS temperature.

(e) *Vehicle level and complete REESS or REESS subsystem level tests for evaluating REESS or vehicle controls for safety of the REESS (paragraphs 5.4.6. to 5.4.10. of this UN GTR)*

174. The following set of tests evaluates the operation of vehicle controls to ensure safety of the REESS under different input conditions to the REESS. The test conditions identified in failure mode effects and criticality analysis are overcharge, over-discharge, over-temperature, low temperature, and over-current. Details of the tests are provided in the following paragraphs. The tests may be conducted at the vehicle level or with a complete REESS or REESS subsystem, as appropriate. For vehicle level tests, the input to the REESS may be applied through normal vehicle operation and charging conditions. Alternatively, the tests may be conducted using a breakout harness to provide the input to the REESS where possible.

(f) *Performance criteria for evaluating REESS or vehicle controls for safety of the REESS*

175. The general performance criteria for the tests of the REESS or vehicle controls is that during the test and for 1 h observation period after the test, there is no evidence of electrolyte leakage, rupture, venting, fire, or explosion, and electrical isolation of the REESS remains greater than 100 Ω/V . The 1 h observation period was selected as a practicable time to evaluate the outcome of each of the tests.

(g) *Overcharge Protection (paragraphs 5.4.6. and 6.2.6. of this UN GTR)*

176. Overcharge of an REESS can occur as a result of a failure of the charging system, such as a fault in an external charger or in a regenerative braking charge system. It may also occur as a result of sensor failure or voltage reference drift. Overcharging of REESS can lead to very high thermal power loss due to current flow and/or loss of chemical stability due to high temperatures. Severe events such as fire or explosion may occur. The aim of the specified test is to verify the performance of the vehicle controls (protection measures) of the REESS against overcharge by an external power supply during its operation. If such protection measures (e.g. battery management system connected to contactors) are installed in the REESS, the functionality of the protection measures shall be proven by terminating or limiting the charge current to a safe value. In the case functionality is not installed and the cells are not protected against overcharge, the REESS has to be charged until the REESS temperature is 10 °C above its maximum operating temperature specified by the manufacturer (based on technical judgement, this temperature value is deemed high enough to cause minor/major damage to the REESS but not dangerous to test personnel). The test end criteria were based on consideration of the practicability of conducting the test, safety to test personnel, and to reduce test time. After the charging is terminated, a standard cycle is conducted if permitted by the Tested-Device (vehicle, REESS, or REESS subsystem(s)).

177. The test is conducted at normal ambient conditions with the SOC adjusted to about midlevel of the range for normal operation. The test may be conducted at the vehicle level or with a complete REESS. At the vehicle level, charge by vehicle operation (driving on a chassis dynamometer) for vehicles that can be charged by on-board energy sources, and charge by external electricity supply for externally chargeable vehicles will be used. For vehicles that have the capability of charging the REESS by external electricity supply and by on-board energy sources, vehicle operation by both methods shall be used. Alternatively, charging of the REESS may be conducted using breakout harness if it can be connected just outside the REESS to charge the REESS with external electricity supply equipment. For test with a complete REESS, external charge/discharge equipment shall be used.

(h) *Over-discharge protection (paragraphs 5.4.7. and 6.2.7. of this UN GTR)*

178. Over-discharging of REESS in itself cannot lead to a severe event. Some kinds of REESS have special chemical reaction which can occur and that are irreversible. Subsequent charging of such an over-discharged REESS may lead to fire or explosion. The aim of the specified test is to verify the performance of the vehicle controls (protection measures) of the REESS against over-discharge during its operation. In the case of the installation of over-discharge protection measures (e.g. battery management system connected to contactors) in the REESS, the functionality of the protection measures shall be proven by terminating the discharge current or the temperature of the REESS is stabilized such that the temperature varies by a gradient of less than 4 °C through 2 hours (this ensures that though the discharge may not be terminated, it is limited to a safe value). If no over-discharge protection measures have been installed, the REESS has to be discharged to 25 per cent of its nominal voltage level. This termination criterion has been given in ISO12405 (Electrically propelled road vehicles - Test specification for lithium-ion traction battery packs and systems) and SAE J2929 (Safety Standard for Electric and Hybrid

Vehicle Propulsion Battery System Utilizing Lithium-based Rechargeable Cells). Finally, a standard charge and a standard discharge shall be conducted, if allowed by the REESS, to assess the influence of the over-discharge.

179. The test is conducted under ambient conditions and started with a low level of SOC to reduce the test time. The test may be conducted at the vehicle level or with a complete REESS or REESS subsystem(s). At the vehicle level, discharge by vehicle operation (driving on a chassis dynamometer) and discharge of REESS through operation of auxiliary equipment (heating, A/C, lights, radio, etc.) shall be conducted. In this case, both the tests for discharge during driving and discharge due to operation of auxiliary equipment shall be conducted because the two discharge modes may result in operation of different vehicle controls. Alternatively, discharging of the REESS may be conducted using a discharge resistor connected to a breakout harness if the harness can be connected to a location just outside the REESS to discharge the REESS. For test with a complete REESS, external charge/discharge equipment shall be used.

(i) *Over-temperature protection (paragraphs 5.4.8. and 6.2.8. of this UN GTR)*

180. This test is to verify the performance of the protection measures of the REESS against internal overheating during the operation, even under the failure or reduced operation of the cooling function, if available. A failed cooling system can lead to higher REESS temperature during the operation and may lead to thermal runaway of cells.

181. The over-temperature test is conducted with a complete REESS or at the vehicle level. In the test with a complete REESS, the temperature of the REESS is increased by charge-discharge operation (within normal mode of operation) with the aid of the high temperature atmosphere until the functionality of the protection measures (e.g. inhibition of charge-discharge, emergency cooling, etc.) are confirmed. In the case that no specific protection measures are necessary to prevent the REESS from reaching an unsafe state due to internal over-temperature, the charge-discharge shall be continued until the temperature of the REESS becomes stable.

182. In the over-temperature test at the vehicle level, the vehicle is placed in a temperature controlled chamber at 40-45 °C (ambient conditions that can be expected for a vehicle in hot climate conditions) for at least 6 hours to raise the temperature of the REESS and the vehicle controls. The vehicle then undergoes charge/discharge cycles to raise the temperature of the REESS while still in the temperature control chamber. The test is terminated when the charge/discharge operation is terminated, the temperature of the REESS is stabilized for 2 hours (this criterion ensures that vehicle operation is within safe levels), or three hours after the charge/discharge operation was initiated. The termination criteria for the test were based on consideration of the practicability of conducting the test and to not unduly prolong the test.

(j) *Overcurrent protection (paragraphs 5.4.9 and 6.2.9. of this UN GTR)*

183. Overcurrent during DC charging (due to control failure of the external charge equipment) could result in heating of the REESS and damage to the cells. Therefore, vehicles with the capability of DC charging through external power supply must ensure overcurrent protection. The test to ensure overcurrent protection is conducted at the vehicle level. The test is conducted at ambient temperature conditions and with an initial SOC in the middle range of normal vehicle operation. There is no need to be more specific about SOC as long as the SOC is not so high that charge is terminated by the overcharge protection control rather than the overcurrent protection control. The test may be conducted by applying the charge current and the overcurrent supply through the DC charging inlet (with disabled charge control communication of the external electricity supply) or through breakout harness connected just outside the REESS. The maximum overcurrent and voltage

(within normal range) that can be applied shall be determined, if necessary, through consultation with the manufacturer. After charging is initiated, the overcurrent is applied 5 s from the highest normal charge current to the overcurrent level determined and is maintained at this level until the overcurrent protection control terminates charging or the temperature is stabilized within 1 hour of initiating the overcurrent.

(k) *Low temperature protection (paragraph 5.2.10. of this UN GTR)*

184. Single time operation of REESS in very cold temperatures cannot lead to a severe event. Some kinds of REESS have special chemical reaction which damage REESS when charged at high rates in very cold temperatures. Subsequent charging of such a damaged REESS may lead to fire or explosion. Therefore, rate of charging may need to be terminated or limited in very cold temperatures. Since no practical test procedure is available at this time to evaluate the performance of vehicle controls in low temperature conditions, manufacturers are required to provide documentation demonstrating that the vehicle monitors and appropriately controls REESS operations at low temperatures at the safety boundary limits of the REESS.

(l) *Management of gases emitted from REESS (paragraph 5.4.11. and Annex 1 of this UN GTR)*

185. Unusual conditions and/or abusive use (overcharge, short circuit, the presence of an external heat source, etc.) can cause sudden increases in temperature of the cell. The pressure generated, e.g. by the vaporization and decomposition of the electrolyte can then lead to mechanical failures within the cell which could cause rupture of its outer casing. In case of a pressure increase, the venting mechanism operates in order to prevent uncontrolled bursting of the cell, which could be detrimental to the preservation of the mechanical integrity of the battery, and therefore detrimental to the occupant. Accordingly, the venting mechanism is an important safety feature widely implemented for automotive batteries.

186. Venting, as defined in paragraph 3.49. of this UN GTR, is the typical cause of emissions from REESS and the phenomena are different between open-type traction batteries and all other types of batteries. Cell venting may result in the release of gases and particulates from the REESS, thereby potentially allowing occupant exposure to the emissions. In general, the vehicle occupants should not be exposed to any hazardous environment caused by emissions from REESS, but the hazard level and amount of such emissions are different depending on the type of batteries and electrolytes.

187. Open-type traction battery means a type of battery requiring filling with liquid and generating hydrogen gas that is released into the atmosphere. UN Regulation No.100 contains a quantitative requirement for hydrogen emissions from open-type traction batteries and there is sufficient experience among respective authorities and manufacturers for safe handling of this type of batteries. Therefore, it is recommended to adopt the same test procedure for this UN GTR as well.

188. Batteries other than open-type traction batteries using aqueous electrolyte, such as NiMH battery or so-called "maintenance-free" lead-acid battery, may have a pressure adjust valve which controls the internal pressure and will re-seal after the excess pressure is released. The vented gases from such batteries contain hydrogen, but the amount of the emitted gases is generally limited to small volume because of durability and reliability reasons. Therefore, no hydrogen emission test is proposed for such batteries.

189. Batteries other than open-type traction batteries using non-aqueous electrolyte such as lithium-ion battery, according to the current state of the art, have certain venting mechanisms to preclude rupture or explosion. In general, the venting phenomena of

lithium-ion battery cells are separated in two cases: (a) associated with combustion and/or decomposition of electrolyte, and (b) only caused by vaporisation of the electrolyte. In case of condition (b), the amount of the gases is considered as less significant to pose additional risk to the occupants. In case of condition (a), the emissions from the cells may increase the risk to vehicle occupants if they are exposed to such substances.

190. Extensive research has shown that gases generated in and vented from Li-ion batteries typically include carbon dioxide (CO₂), carbon monoxide (CO), hydrogen (H₂), oxygen (O₂), light C₁-C₅ hydrocarbons, e.g. methane and ethane, and fluorine-containing compounds such as hydrogen fluoride (HF) and fluoro-organics such as e.g. ethyl fluoride.^{15, 16, 17, 18, 19} Hazards associated with toxicity, corrosiveness and flammability of gases emitted from batteries are recognized in various standards and regulations such as ISO 6469-1, SAE J2464, SAE J2929, UL 2580 and Recommendations on the Transport of Dangerous Goods, Manual of Tests and Criteria, paragraph 38.3. For 18650 cells, in average circa 1.2 l of gas (Standard Temperature and Pressure (STP)) can be vented for each ampere hour (Ah) of cell capacity.²⁰

191. To avoid human harm that may occur due to potential toxic or corrosive emissions, for REESS other than open-type traction batteries, venting is adopted as a pass/fail criterion for the following in-use tests: vibration, thermal shock and cycling, external short circuit protection, overcharge protection, over-discharge protection, over-temperature protection and over-current protection. This regulation includes a no-fire criterion which addresses the issue of vented gas flammability.

192. The informal working group examined the feasibility to establish a robust and repeatable method to verify the occurrence of venting and the potential exposure of vehicle occupant to the gases caused by venting condition (a) associated with combustion and/or decomposition of electrolyte, in the in-use test. Several ideas from Japan, JRC and OICA were discussed but no suitable method, other than visual technique, was found at this stage for verifying the occurrence of venting as a basis for assessing the influence of venting gases to vehicle occupants. Venting described in condition (a) will cause certain traces such as soot, electrolyte residues that can be identified even in post-test inspections. Accordingly, an additional criterion to assess the occurrence of venting that can be visually observed without disassembling the Tested-Device is required for the tests simulating the in-use operations.

(m) *Thermal propagation (paragraph 5.4.12. of this UN GTR)*

193. Usually when a cell undergoes thermal runaway, it will transfer heat to adjacent cells via conductive, convective, and radiative heat transfer modes. By heat transfer, the thermal runaway in a single cell may propagate to the surrounding cells, causing reactions to create fire or, in very rare circumstances, explosion. Thermal runaway is a characteristic of the lithium ion battery which is currently used in many REESS for electric vehicle. Thermal runaway reaction occurs when the thermal stability limit of the cell chemistry is

¹⁵ S. Koike, M. Shikano, H. Sakaebe, H. Kobayashi, "Study of generative gas species from lithium-ion battery component under abuse conditions", Abstract # 1009, Honolulu 2012, The Electrochemical Society Meeting.

¹⁶ M. Onuki, S. Kinoshita, Y. Sakata, M. Yanagidate, Y. Otake, M. Ue, M. Deguchi, J. Electrochem. Soc., 2008, 155, A794.

¹⁷ C. Mikolajczak, M.Kahn, K. White, R.T. Long, "Lithium-Ion batteries hazard and use assessment", Springer, 2011 and references therein.

¹⁸ W.Kong, H.Li, X.Huang, L.Chen, J.Power Sources, 2005, 142, 285.

¹⁹ A. Hammami, N. Raymond, M. Armand, Nature, 2003, 424, 635-636.

²⁰ E.P. Roth, C.J. Orendorff, "How electrolytes influence battery safety", Interface, Summer 2012, p.45.

exceeded, and the cell releases its energy exothermically at an uncontrolled rate. The thermal runaway occurs with smoke, fire and, in extreme cases, possibly even explosion. The smoke contains flammable or toxic vapours, can become very hot, can ignite, can contain corrosive or toxic substances, or can result in an energetic disassembly of the cell. Fire is very common during thermal runaway, given the gas emission. The smoke, fire and explosion threaten the safety of electric vehicle occupants. The hazard caused by thermal runaway must be restricted.

194. Although the battery in REESS can pass current test standards, including Recommendations on the Transport of Dangerous Goods, Manual of Tests and Criteria, paragraph 38.3, UN Regulation No. 100, SAE-J2464, IEC-62133, GB/T-31485, thermal runaway still occurs sporadically in practical operations due to, for example, internal short circuit.

195. The internal short circuit of lithium ion battery has already been reported in field failures (e.g. in consumer products). Requirements are needed to ensure that an internal short failure occurring in an electric vehicle does not lead to significant risks for vehicle occupants. However, no existing test standards can well simulate the thermal runaway triggered by internal short circuit. The mechanism of internal short circuit is complex and requires years of further study. However, it is certain that by rigorous control in the manufacturing as well as improvements in cell design such as use of non-flammable electrolytes, ionic liquids, heat resistant and puncture-proof separators, improved anode and cathode materials, the possibility of spontaneous internal short circuit can be diminished.

196. Nevertheless a test is required to demonstrate that potential risks to vehicle occupants associated with thermal propagation are appropriately minimized. Such a test needs to fulfil the following conditions:

- (a) The triggering of thermal runaway at single cell level must be repeatable, reproducible and practicable;
- (b) The judgement of thermal runaway through common sensors, e.g. voltage and temperature, needs to be practical, repeatable and reproducible;
- (c) The judgement of whether consequent thermal event involves severe thermal propagation hazard needs to be unequivocal and evidence-based.

197. Acknowledging the safety risks associated with Thermal Propagation (TP), the working group under the leadership of China, thoroughly considered extensive research performed and generously shared by China and other parties. Recognising the rapid evolution of EV technology, the practical experience gained in recent years and the increased expected uptake of EVs, the working group concluded that coverage and comprehensive treatment of TP is of crucial importance.

198. Notwithstanding the divergent opinions from different experts and the still dynamic situation regarding research, the urgent need to agree a practical solution for Phase 1 which guarantees an acceptable level of safety to occupants until a more robust solution is developed in Phase 2, is recognised. It means a consistent test procedure will finally replace the interim documentation requirement.

199. As the result of thermal propagation, the cell may emit gases which can exit from the REESS. Regarding the risk of gases, the working group made the following observation in EVS-12-07: "Assessment of potential safety risks of this requires more research to evaluate whether limits for emissions are required, for which species and which technique can be used to measure these. It was not possible to research and analyse this in Phase 1. Therefore, it will be considered in Phase 2 of this Regulation."

200. Given the limitations surrounding development of a specific test to evaluate single cell thermal runaway, it was decided to require the manufacturer to submit engineering documentation to demonstrate the vehicle's ability to minimize the risk associated with single cell thermal runaway.

201. With this approach, manufacturers are obliged to implement and validate the countermeasures to minimize or prevent single cell thermal runaway and its propagation in the REESS. As a result, the safety performance of the electric vehicles in the market will effectively be improved. The test procedures considered during the Phase 1 of this regulation (see Section C) might be referenced by several manufacturers for the purpose of complying with this documentation requirement and will allow industries and Contracting Parties to accumulate the practical experiences that would contribute for further development of standardized test procedure.

202. In summary, the purpose of the thermal propagation test as well as engineering documentation is to verify the thermal-propagation performance of the REESS when a single cell undergoes the thermal runaway.

9. Post-crash safety of REESS

203. In case a vehicle crash test is conducted with REESS, the requirements of electrolyte leakage (5.5.1.1), REESS retention (5.5.1.2.) and fire hazard (5.5.1.3.) of this UN GTR shall be satisfied. The component based test requirements provided in paragraph 5.5.2. of this UN GTR are considered as an alternative to these requirements, if the vehicle crash test is not applicable or not conducted at a manufacturer's choice (e.g. when changing the battery supplier during the model life.)

204. These criteria are established with the assumption that the vehicle user is supposed to stop using the vehicle until certain repair/maintenance is conducted once subject to the event. In this case, any additional risk to the occupants and the surrounding people should be mitigated at a reasonable level. The requirements of electrolyte leakage (5.5.1.1.) and REESS retention (5.5.1.2.) of this UN GTR are based on the existing requirements of UN Regulations Nos. 12, 94 and 95 as well as the 02 series of amendments to UN Regulation No. 100. Within 60 minutes after the impact, there shall be no electrolyte leakage into the passenger compartment. This time period is related to the time needed for occupants to be rescued from a crashed vehicle.

(a) *Mechanical shock (paragraphs 5.5.2.1.1. and 6.2.10. of this UN GTR):*

205. The aim of this requirement is to verify the safety performance of the REESS under inertial loads which may occur during an impact.

206. Existing regulations UN Regulations Nos. 67 and 110 already require inertial load validations for container for LPG and Compressed Natural Gas (CNG) on component level. Furthermore, the same inertial load requirements are implemented in the new regulation 79/2009 (EC) for hydrogen vehicles and in the Japanese regulation "Attachment 111" for the installation of high-voltage components. The acceleration values in the above-mentioned regulations are defined and verified for each vehicle category. The inertial load values based on existing regulations are adopted for the REESS mechanical shock test on component level as well. Additionally, a pulse shape and a pulse time have been defined to ensure the repeatability and equivalency of the test. The shape and time are derived from the acceleration pulse of UN Regulation No.17 (seat strength).

(b) *Mechanical integrity (paragraphs 5.5.2.1.2. and 6.2.11. of this UN GTR)*

207. The aim of this requirement is to verify the safety performance of the REESS under contact loads which may occur during vehicle crash.

208. In order to enable the generic component testing/certification approach, a generic component based integrity test for the REESS was developed.

209. The loads have been derived from REESS contact loads which have been observed on vehicle crash tests according to UN Regulations Nos. 12, 94 and 95, using electric and hybrid-electric vehicles which were available on the market. The REESS were installed in various installation positions (see Figure 23).

210. The contact loads onto the REESS observed during the above tests and simulations did not exceed 100 kN (see Table 4).

Figure 23
Location of REESS

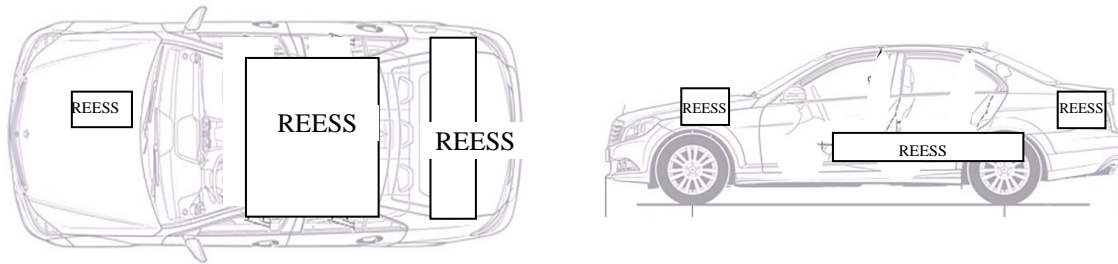

Table 4
Maximum contact load

<i>Vehicle</i>	<i>REESS position</i>	<i>Maximum contact load</i>
S 400 HYBRID	Front	} 100 kN
ML 450 HYBRID	Rear Axle	
B-Class F-CELL	Rear Axle	
A-Class E-CELL	Floor	
Smart ED	Floor	

211. Figure 24 shows, that the REESS in the investigated vehicles are not installed in the extreme positions of the front or the rear of the vehicle. This is confirmed by vehicle independent investigations (SAE 2011-01-0545 Analysis of Fuel Cell Vehicles Equipped with Compressed Hydrogen Storage Systems from a Road Accident Safety Perspective) that show that, statistically, the highest rates of the deformation will be observed at the front end and, at a smaller level, at the rear end of the vehicle (see Figure 24). Therefore, these installation locations shall be excluded if the REESS is approved according to the generic 100 kN integrity test according to paragraph 6.2.11. of this UN GTR.

Figure 24

Cumulative frequency and 5th percentile in cars registered in 2000 and later

(SAE 2011-01-0545 Analysis of Fuel Cell Vehicles Equipped with Compressed Hydrogen Storage Systems from a Road Accident Safety Perspective)

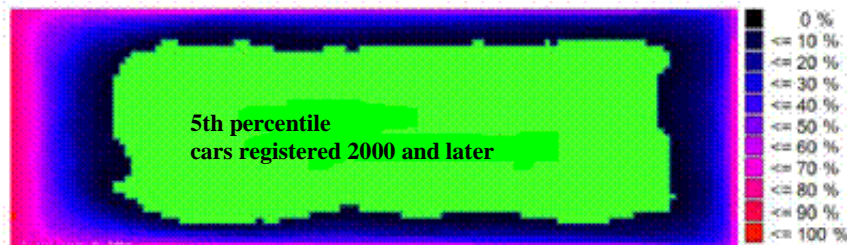

212. The dimension of the restricted mounting zones for the generically approved REESS is derived from the Japanese regulation Attachment 111 (technical standard for protection of occupants against high voltage after collision in electric vehicles and hybrid electric vehicles). Considering this regulation, the installation of the REESS is prohibited in an area 420 mm from the front of the vehicle rearwards and 300 mm from the end of the vehicle forwards (see Figure 25).

Figure 25

Prohibited installation positions (red) for vehicle independent approved REESS

213. Although the whole vehicle crash test is a dynamic event with a very short duration time for the maximum REESS load, a static component test is proposed in paragraph 6.2.11. for the vehicle independent testing of the REESS. Being aware that a quasi-static load application might lead to a higher test severity, achieving a high pre-defined force level in a controllable manner is easier to conduct via a quasi-static testing.

214. Considering this, a REESS subjected to the maximum observed contact load in the direction of travel and horizontal perpendicular to this direction can be assumed as safe in the event of a vehicle crash.

215. The static REESS load that shall be reached is therefore proposed as 100 kN with a maximum aberration of 5 per cent to an upper threshold of 105 kN. The hold time of the maximum force shall be at least 100 ms as an agreed duration of the crash pulse during vehicle crash tests but shall not exceed 10 s to avoid unrealistic severity. For the same reason, the onset time for reaching the maximum contact load is limited to 3 minutes. To allow the manufacturer more flexibility and since it makes the conditions more severe, higher forces, longer onset time and a longer hold time shall be allowed if requested by the manufacturer. The crush plate from SAE J2464 is used to apply the contact load.

216. To enable the manufacturer of the REESS to achieve a certification at component level for the REESS and considering that in numerous cases the contact load of the REESS during a vehicle crash may be lower than the above required worst case 100 kN.

217. The manufacturer may conduct the integrity test with a lower crush force than 100 kN, but, in this case, the vehicle manufacturer installing the REESS in the vehicle, shall provide evidence, that, in the discussed vehicle application, the contact load on the REESS during vehicle crash does not exceed the crush force applied for the certification test of the REESS.

(c) *Rationale for leakage detection technique*

218. The vehicle user is expected to be able to continue vehicle operation after the in-use events (e.g., vibration, thermal shock etc.). The "electrolyte leakage" can be a sign of internal damage. In this case, stringent requirements should be applied, which is "no leakage". The informal working group propose to use visual inspection for leakage detection, which is used in the 02 series of amendments to UN Regulation No.100.

219. For post-crash events the user is expected to cease vehicle operation until certain repair/maintenance is conducted. In this case, the requirement relevant to the accident situation, in order to avoid additional risk to the occupants and the surrounding people, should be applied. Here the main concern is the human contact with the corrosive/toxic electrolyte and not the internal damage of the REESS. This is why most of the international regulations, such as FMVSS 305, UN Regulations Nos.12, 94 and 95, limit the amount of electrolyte leaked.

220. The main concern for the "aqueous electrolyte REESS" is the potential corrosive nature of the electrolyte and hence during the post-crash situation any human contact (occupant as well as the person surrounding the accident site) with the electrolyte should be avoided. As significant amount of electrolyte is expected, the informal working group found that the measurement techniques provided in the FMVSS 305 is best suited to measure the amount of leaked aqueous electrolyte.

221. The amount of leakage for "non-aqueous electrolyte REESS" is expected to be lower than in the case of 'aqueous electrolyte REESS'. This quantity, particularly if small, may not be easily measurable with existing techniques (EVSTF-04-13e). The 'non-aqueous electrolytes' are potentially toxic, irritant or harmful in addition to being flammable. This UN GTR requires that there should not be any visible leakage outside the vehicle. This will ensure no contact between the electrolyte and the people surrounding the crash site. In addition, there shall be no leakage inside the passenger compartment in order to avoid contact with occupant. This will be verified by visual inspection and this method is in line with existing regulations such as UN Regulations Nos. 12, 94, 95 and FMVSS 305.

222. Electrolyte leakage can occur as the result of mechanical damage to REESS, e.g. in a vehicle crash. Electrolyte leakage can lead to a potential hazardous situation that can cause human harm from contact with electrolyte and/or electrolyte residue. Risk of human harm is mitigated by adopting a requirement on electrolyte leakage in the tests addressing REESS safety post-crash and stipulating 60 minutes observation time.

223. The observation time for electrolyte leakage in the vehicle crash test is 60 minutes, which is related to the time needed for occupants to be rescued from a crashed vehicle. Recent and historical data show that the average time that elapses from the moment of crash to the moment when the occupants of a crashed vehicle are removed from a crash scene, i.e. the duration of potential exposure to leaked electrolyte, often approaches 60 minutes.^{21, 22, 23, 24}

²¹ Y. Sukegawa, M. Sekino, "Analysis of rescue operations of injured vehicle occupants by fire fighters", paper#11-0101, presented at the 22nd Enhanced Safety of Vehicles Conference (ESV-22), Washington DC, June 2011. www.nrd.nhtsa.dot.gov/departments/esv/22nd/

Similarly, the data shows that time needed from site arrival to rescue of the occupant from the vehicle was 20 minutes on average and the average exceeded 30 minutes when there were two or more persons to be rescued.

224. Recommendations on the duration of the observation time may be reconsidered in the future with implementation and an effective operation of in-vehicle communication systems (e.g. e-call requirements to be implemented in the EU from 2018 onwards).²⁵ In this case, the required observation time during the in-vehicle test may be reduced, provided that the vehicle is equipped with an in-vehicle communication system and the accompanying infrastructure supporting an effective communication is ensured across the entire territory of a 1998 Ag. CP.

225. The observation time for electrolyte leakage in the REESS-based tests for mechanical integrity (5.5.2.1.2.) and mechanical shock (5.5.2.1.1.) tests of this UN GTR is 60 minutes.

226. For the time being, venting is not adopted as a requirement for tests addressing post-crash safety of REESS. Assessment of potential safety risks of this requires more research to evaluate whether limits for emissions are required, for which species and which technique can be used to measure these. It was not possible to research and analyse this in Phase 1. Therefore, it will be considered in Phase 2 of this UN GTR.

227. During the informal working group discussion, and based on analysis and data provided by JRC, a potential risk related to the release and evaporation of non-aqueous electrolyte and the potential formation of a toxic atmosphere was discussed (EVSTF-04-13e, EVS-07-24e).²⁶ As of now, and although the topic is mentioned in various standards, (UL 2580, SAE J2464, SAE J2289, SAE J2990, ISO 6469) some of which even recommend gas/analytical detection techniques, there is no clear measurement procedure suitable for all scenarios (component/vehicle level, in-use/post-crash). Even with consideration of the huge amount of electric and hybrid vehicles that are already on the street in Asia, North America and Europe, incidents of evaporation especially during in-use are not yet documented. Nevertheless, more field or research data is required to define an analytical technique suitable for detecting on evaporated species from leaked electrolyte. Based on the outcome of this research, modifications to the requirements and methods with respect to leakage and evaporation of non-aqueous electrolyte may be necessary in the future.

10. Rationale for Heavy duty vehicles` requirements

228. REESS comprising, multiple battery pack solutions are rather common in heavy vehicle applications. For these cases, compliance testing on battery pack level is admissible if the battery pack is a well-defined entity with some level of BMS control.

²² H. Johannsen, G. Muller, C. Pastor, R-D. Erbe, H-G. Schlosser, "Influence of new car body design on emergency rescue", paper presented at the 4th International Conference on ESAR "Expert Symposium on Accident Research", Hannover, September 2010; <http://bast.opus.hbz-nrw.de/volltexte/2012/556/>

²³ L.E. Shields, "Emergency Response Time in Motor Vehicle Crashes: Literature and Resource Search", report prepared for Motor Vehicle Fire Research Institute, January 2004. http://www.mvfri.org/Contracts/Final%20Reports/Shields_Report-01.pdf

²⁴ <http://www.imobilitysupport.eu/library/ecall/ecall-implementation-platform/eeip-meetings/2009-4/01-oct-2009/1236-eeip-adac-accident-research-01-oct-2009/file>

²⁵ <https://ec.europa.eu/digital-agenda/en/ecall-time-saved-lives-saved>

²⁶ N.P. Lebedeva, L. Boon-Brett, "Considerations on the chemical toxicity of contemporary Li-ion battery electrolytes and their components", J Electrochem Soc, 2016, 163, A821-A830.

229. In this regulation, safety requirements for heavy duty vehicles cover general electrical safety for vehicle, vehicle specific functional safety, REESS safety in-use and inertial load on REESS.

230. For most part, the tests and requirements for heavy vehicles are the same as for passenger vehicles. The following paragraphs will address modifications and/or deviations that are specific to and motivated by heavy vehicle applications.

(a) *Electrical safety for vehicle*

231. The fundamentals for protecting against an electrical shock and the technical justification for the requirements are the same for both light vehicles and heavy duty vehicles (see paragraphs 41 – 53 above).

232. The risk for direct contact depends on the location of the charging interface on the vehicle. Charging interfaces, located out of reach are exempted from the requirements of direct contact for all heavy duty vehicles. Anthropometric data^{27,28} has been used to calculate appropriate distances for Category 1-2 vehicles with roof mounted charging devices to safe-guard vehicle occupants. Calculation of wrap around distance for roof mounted charging devices for Category 2 vehicles will be considered in UN GTR phase 2 since these operate on different principles and the technology is less mature. Until this time, Category 2 vehicles which are professionally operated are exempted. Out of reach conditions for live parts located underneath for all heavy duty vehicles will be investigated in UN GTR phase 2.

233. Overcurrent protection will be considered in UN GTR phase 2 for heavy vehicles due to time constraints. The current test proposal is vehicle based and was deemed inappropriate for heavy vehicles as it is unclear how to apply on vehicles that have different charging technologies. More discussion is needed in phase 2 to address different charging methodologies.

(b) *Vehicle specific functional safety*

234. Driving disabled when charging only applies for vehicles when charging from a fixed, dedicated charging point, with a harness of a maximum length, through a vehicle connector containing a plug and inlet. There is a general development direction for heavy vehicles towards minimizing human intervention when charging, which implies other technology solutions than socket and plug connection. This is a prerequisite for efficient opportunity charging, which is a method of extending the driving range for heavy vehicles without having to use up valuable loading capacity of the vehicle or incur additional cost by increasing the electric capacity of the REESS. Examples of technologies include, but are not limited to pantograph connection on the roof, and charging while driving on so-called electric roads, where electric power is temporarily fed into the vehicle en-route, from air cables or conductive leads in the pavement.

(c) *REESS safety in-use*

235. The vibration modes of heavy vehicles vary significantly between applications. Hence heavy vehicles are likely to exercise the possibility of compliance testing against an

²⁷ Pheasant, S. (1996) Bodyspace – Anthropometry, Ergonomics and the Design of Work, London: Taylor & Francis.

²⁸ Gordon, C.C. et al. (1989) Anthropometric Survey of U.S. Army Personnel: Interim Report. United States Army Natick Research, Development and Engineering Center, Natick, Massachusetts. <http://www.dtic.mil/dtic/tr/fulltext/u2/a209600.pdf>

application specific vibration profile. Generally, vibration modes in heavy vehicles are more severe than for passenger vehicles.

236. In the case of a REESS consisting of multiple battery packs, sub-system testing on battery pack level is often relevant and a more practical and cost effective way of performing the tests, also because of equipment constraints at testing services.

(d) *Inertial load on REESS safety*

237. There are no crash tests for heavy vehicles that are equivalent to e.g. Regulations Nos. 94 and 95. For this reason, mechanical integrity requirements are not included and only inertial loads in mechanical impact are tested. The inertial load levels have been adapted to be representative for trucks and buses for GVM between 3,500 kg and 12,000 kg and GVM above 12,000 kg, respectively.

F. Recommendations

1. Topics for the next phase in developing the UN GTR on Electric Vehicle Safety

238. Since electric vehicles are still expected to develop with an extended time of on-road experience and technical evaluations, it is possible that revisions to these requirements may be required.

239. Moreover, additional discussion is required on some critical issues identified by the informal working group, where research and testing of methods is still in progress or needs to be verified by Contracting Parties.

240. Focus topics for Phase 2 are expected to include:

- (a) water immersion test;
- (b) long-term fire resistance test;
- (c) REESS rotation tests;
- (d) REESS vibration profile;
- (e) flammability, toxicity and corrosiveness of vented gas (e.g. quantification of venting for tests addressing safety of REESS post-crash, potential risk of 'toxic gases' from non-aqueous electrolyte);
- (f) thermal propagation and methods of initiation in battery system;
- (g) post-crash REESS safety assessment and stabilization procedures;
- (h) light electric vehicles (e.g. categories L₆ and L₇²⁹);
- (i) protection during AC and DC charging and feeding process.

2. Fuel cell electric vehicles

241. Current UN GTR No.13, global technical regulation on hydrogen and fuel cell vehicles, also includes electrical safety requirements. The informal working group thoroughly reviewed, discussed and agreed the technical requirements for protection against electric shock applicable for any kinds of electric powertrain foreseeable today including those of fuel cell electric vehicles. In order to avoid any inconsistencies between the two

²⁹ As defined in the Consolidated Resolution on the Construction of Vehicles (R.E.3.), document ECE/TRANS/WP.29/78/Rev.6, para. 2.

UN GTRs, the informal working group recommends WP.29 to revise UN GTR No. 13 by removing the requirements on electrical safety with reference to this UN GTR. It is also recommended that any Contracting Party that intends to implement UN GTR No. 13 into their national legislation before the amendment recommended above, should use the technical requirements of this regulation with respect to the electrical safety rather than those currently in UN GTR No. 13.

3. Confidentiality of information

242. As described in section E above, this UN GTR includes specific requirements for manufacturer to provide technical documentations that address specific aspects, such as REESS warnings (paragraphs 5.3.2., 5.3.3., 7.2.2. and 7.2.3.), low-temperature protection (paragraphs 5.4.10. and 7.3.10.) and thermal propagation (paragraphs 5.4.12. and 7.3.12.). In order to describe the required aspects sufficiently, such documentation will include manufacturer's confidential and proprietary information, where it is indispensable to protect the intellectual properties therein. Accordingly, 1998 Ag. Cps. implementing this regulation should take necessary measures to protect such intellectual properties by allowing confidential treatment of the documentation if requested by the manufacturer.

G. Existing regulations, directives, and international voluntary standards³⁰

243. International, national regulations, recommendation and directives:

- The United States of America -- FMVSS 305 – Electric-Powered Vehicles: Electrolyte Spillage and Electrical Shock Protection
- UN Regulation No. 12 – Concerning the adoption of uniform conditions of approval and reciprocal recognition of approval for motor vehicle equipment and parts
- UN Regulation No. 94 – Uniform provisions concerning the approval of vehicles with regard to the protection of the occupants in the event of a frontal collision
- UN Regulation No. 95 – Uniform provisions concerning the approval of vehicles with regard to the protection of the occupants in the event of a lateral collision
- UN Regulation No. 100 – Uniform provisions concerning the approval of vehicles with regard to specific requirements for the electric power train
- UN Regulation No. 137 – Uniform provisions concerning the approval of passenger cars in the event of a frontal collision with focus on the restraint system
- Japan – Attachment 101 – Technical Standard for Protection of Occupants against High Voltage in Fuel Cell Vehicles
- Japan – Attachment 110 – Technical Standard for Protection of Occupants against High Voltage in Electric Vehicles and Hybrid Electric Vehicles
- Japan – Attachment 111 – Technical Standard for Protection of Occupants against High Voltage after Collision in Electric Vehicles and Hybrid Electric Vehicles
- Japan – Circular notice for test procedures with Hard-In-the-Loop Simulator system to measure fuel efficiency and emission in Electric Hybrid Heavy-duty Vehicles (H19.3.16, KOKU-JI-KAN No.281)

³⁰ As of 6 December 2016.

- China – GB/T 31484:2015 - Cycle life requirements and test methods for traction battery of electric vehicle
 - China – GB/T 31485:2015 - Safety requirements and test methods for traction battery of electric vehicle
 - China – GB/T 31486:2015 - Electrical performance requirements and test methods for traction battery of electric vehicle
 - China – GB/T 31467.3:2015 - Lithium-ion traction battery pack and system for Electric vehicles— Part 3: Safety requirements and test methods
 - China – GB/T 18384.1:2015 - Electrically propelled road vehicles-Safety specifications-Part 1: On-board Rechargeable Energy Storage System (REESS)
 - China – GB/T 18384.2:2015 - Electrically propelled road vehicles-Safety specifications-Part 2: Vehicle operational safety means and protection against failures
 - China – GB/T 18384.3:2015 - Electrically propelled road vehicles-Safety specifications-Part 3 Protection of persons against electric shock
 - China – GB/T 31498:2015 – The safety requirement of electric vehicle post crash
 - China – GB/T 24549:2009 - Fuel cell electric vehicles - Safety requirements
 - Canada – CMVSS 305 – Electric Powered Vehicles: Electrolyte Spillage And Electrical Shock Protection
 - Republic of Korea – Motor Vehicle Safety Standard, Article 18-2 – High Voltage System, Test Procedure Table 1 – Part 47. Safety Test for High Voltage System
 - Republic of Korea – Motor Vehicle Safety Standard, Article 18-3 – Rechargeable Energy Storage System (REESS), Test Procedure Table 1 – Part 48. Safety Test for REESS
 - Republic of Korea – Motor Vehicle Safety Standard, Article 91-4 – High Voltage System in Crash test, Test Procedure Table 1 – Part 47. Safety Test for High Voltage System
 - Recommendations on the Transport of Dangerous Goods, Manual of Tests and Criteria, paragraph 38.3 (LITHIUM METAL AND LITHIUM ION BATTERIES)
244. List of relevant standards for Electric Vehicle Safety:
- ISO 6469-1:2009 Electrically propelled road vehicles - Safety specifications - Part 1: On-board rechargeable energy storage system (remark: Standard is under review to incorporate the requirements from ISO12405-3 to apply all types of REESS)
 - ISO 6469-2:2009 Electrically propelled road vehicles - Safety specifications - Part 2: Vehicle operational safety means and protection against failures
 - ISO 6469-3:2011 Electrically propelled road vehicles - Safety specifications - Part 3: Protection of persons against electric shock
 - ISO 6469-4:2015 Electrically propelled road vehicles - Safety specifications - Part 4: Post crash electrical safety
 - ISO 17409:2015 Electrically propelled road vehicles-- Connection to an external electric power supply - Safety requirements
 - ISO/TR 8713: 2012 Electrically propelled road vehicles - Vocabulary

- ISO/IEC 15118-1:2013 Road vehicles - Vehicle to grid communication interface - Part 1: General information and use-case definition
- ISO/IEC 15118-2:2014 Road vehicles - Vehicle to grid communication interface - Part 2: Network and application protocol requirements
- ISO/IEC 15118-3:2015 Road vehicles - Vehicle to grid Communication Interface - Part 3: Physical and data link layer requirements
- ISO/IEC 15118-4(draft) Road vehicles - Vehicle to grid communication interface - Part 4: Network and application protocol conformance test
- ISO/IEC 15118-5(draft) Road vehicles - Vehicle to grid communication interface - Part 5: Physical layer and data link layer conformance test
- ISO 26262 series:2011 Road vehicles - Functional safety
- ISO 6722-1:2011 Road vehicles - 60 V and 600 V single-core cables - Part 1: Dimensions, test methods and requirements for copper conductor cables
- ISO 6722-2:2013 Road vehicles - 60 V and 600 V single-core cables - Part 2: Dimensions test methods and requirements for aluminum conductor cables
- ISO 12405-1:2011 Electrically propelled road vehicles - Test specification for lithium-ion traction battery packs and systems - Part 1: High-power applications (Remark: This standard will be withdrawn replaced with ISO12405-4.)
- ISO 12405-2:2012 Electrically propelled road vehicles - Test specification for lithium-ion traction battery packs and systems - Part 2: High-energy applications (Remark: This standard will be withdrawn replaced with ISO12405-4.)
- ISO 12405-3:2014 Electrically propelled road vehicles - Test specification for lithium-ion battery packs and systems - Part 3: Safety performance requirements (Remark: This standard will be withdrawn and merged into ISO6469-1.)
- ISO 12405-4(draft) Electrically propelled road vehicles -Test specification for lithium-ion traction battery packs and systems - Part 4: Performance testing (Remark: ISO12405-1 and ISO12405-2 will be merged as this standard.)
- IEC 61851-1:2017 Electric vehicle conductive charging system - Part 1: General requirements
- IEC 61851-21: 2001 Electric vehicle conductive charging system - Part 21: Electric vehicle requirements for conductive connection to an a.c./d.c. supply (Remark: This standard is under review and will change into EMC standards (IEC61851-21-1 and IEC61851-21-2), the relevant requirements for electrical safety moved to ISO 17409)
- IEC 61851-21-1(draft) Electric vehicle conductive charging system - Part 21-1 Electric vehicle on-board charger EMC requirements for conductive connection to a.c./d.c. supply
- IEC 61851-21-2(draft) Electric vehicle conductive charging system - Part 21-2: EMC requirements for OFF board electric vehicle charging systems
- IEC 61851-23:2014 Electric vehicles conductive charging system - Part 23: DC electric vehicle charging station
- IEC 61851-24:2014 Electric vehicles conductive charging system - Part 24: Digital communication between a d.c. EV charging station and an electric vehicle for control of d.c. charging

- IEC 62196-1:2014 Plugs, socket-outlets, vehicle connectors and vehicle inlets - Conductive charging of electric vehicles - Part 1: General requirements
- IEC 62196-2:2011 Plugs, socket-outlets, vehicle connectors and vehicle inlets - Conductive charging of electric vehicles - Part 2: Dimensional compatibility and interchangeability requirements for a.c. pin and contact-tube accessories
- IEC 62196-3:2014 Plugs, socket-outlets, and vehicle couplers - conductive charging of electric vehicles - Part 3: Dimensional compatibility and interchangeability requirements for dedicated d.c. and combined a.c./d.c. pin and contact-tube vehicle couplers
- IEC 62660-2:2010 Secondary lithium-ion cells for the propulsion of electric road vehicles – Part 2: Reliability and abuse testing
- IEC 62660-3:2016 Secondary lithium-ion cells for the propulsion of electric road vehicles – Part 3: Safety requirements of cells and modules
- IEC 62752:2016 In-cable control and protection device for mode 2 charging of electric road vehicles (IC-CPD)
- SAE J1766:2014 Recommended Practice for Electric and Hybrid Electric Vehicle Battery Systems Crash Integrity Testing
- SAE J1772:2016 Electric Vehicle and Plug in Hybrid Electric Vehicle Conductive Charge Coupler
- SAE J2578:2014 Recommended Practice for General Fuel Cell Vehicle Safety
- SAE J2929:2013 Safety Standard for Electric and Hybrid Vehicle Propulsion Battery Systems Utilizing Lithium-based Rechargeable Cells
- SAE J2464:2009 Electric and Hybrid Electric Vehicle Rechargeable Energy Storage System (RESS) Safety and Abuse Testing
- SAE J2344:2010 Guidelines for Electric Vehicle Safety
- SAE J2380:2009 Vibration Testing of Electric Vehicle Batteries
- UL 2580:2013 Batteries for Use In Electric Vehicles

H. Benefits and costs

245. At this time, the UN GTR does not attempt to quantify costs and benefits for Phase 1. While the goal of the UN GTR is to enable increased market penetration of EV, the resulting rates and degrees of penetration are currently insignificant and may vary substantially from one Contracting Party to another and from one year to another. Therefore, a quantitative cost-benefit analysis would not be meaningful.

246. Some costs are anticipated from greater market penetration of EV. For example, building the infrastructure required to make EV a viable alternative to conventional vehicles will entail significant investment costs for the private and public sectors, depending on the Contracting Party. In addition, research and investment in development and production of next generation batteries and battery cells may represent a substantial upfront cost that will largely continue to depend on a sizeable public support.

247. Nevertheless, the Contracting Parties believe that the benefits of UN GTR are likely to significantly outweigh costs overtime. Widespread use of EV, with the establishment of the necessary charging infrastructure, EV becoming more affordable to large masses of population due to battery/cell price reduction and the improved driving range and

durability, is anticipated to reduce the number of gasoline and diesel vehicles on the road, which should reduce worldwide consumption of fossil fuels. Perhaps most notably, the reduction in greenhouse gas (CO₂) and criteria pollutant emissions (such as NO₂, SO₂, and particulate matters) associated with the widespread use of EV is anticipated to result in significant societal benefits over time by alleviating climate change and health impact costs. The pollution in the areas which are most densely populated will decrease thus limiting exposure of the citizens to harmful substances. Furthermore, decreased demand for fossil fuels is likely to lead to energy and national security benefits for those countries with widespread EV use. It is also expected that old batteries from EV will find a second-life usage as energy storage for energy network, thus mitigating fluctuation resulting from volatility of the energy supply from renewables.

248. The new market for innovative design and technologies associated with EV, including battery and cell production may create significant employment benefits. Moreover, it is not certain whether employment losses associated with the lower production of conventional vehicles would offset those gains.

II. Text of Regulation

1. Purpose

This regulation specifies safety-related performance of electrically propelled road vehicles and their rechargeable electric energy storage systems. The purpose of this regulation is to avoid human harm that may occur from the electric power train.

2. Scope

2.1. This regulation applies to vehicles of Category 1 and Category 2 with a maximum design speed exceeding 25 km/h, equipped with electric power train containing high voltage bus, excluding vehicles permanently connected to the grid.

2.2. This regulation includes the following two sets of requirements that may be selected by Contracting Parties according to the category and gross vehicle mass (GVM) of the vehicles:

- (a) For all vehicles of Category 1-1 and vehicles of Categories 1-2 and 2 with GVM of 4,536 kg or less, the requirements of paragraphs 5 and 6 shall apply in accordance with the general requirements specified in paragraph 4;
- (b) For vehicles of Category 1-2 and Category 2 with GVM exceeding 3,500 kg¹, the requirements of paragraphs 7 and 8 shall apply in accordance with the general requirements specified in paragraph 4.

2.3. Contracting Parties may exclude the following vehicles from the application of this regulation:

- (a) A vehicle with four or more wheels whose unladen mass is not more than 350 kg, not including the mass of traction batteries, whose maximum design speed is not more than 45 km/h, and whose engine cylinder capacity and maximum continuous rated power in the case of hybrid electric vehicles do not exceed 50 cm³ for spark (positive) ignition engines and 4 kW for electric motors respectively; or whose maximum continuous rated power in the case of battery electric vehicles does not exceed 4 kW; and
- (b) A vehicle with four or more wheels, other than that classified under (a) above, whose unladen mass is not more than 450 kg (or 650 kg for vehicles intended for carrying goods), not including the mass of traction batteries and whose maximum continuous rated power does not exceed 15 kW.

¹ For vehicles with GVM exceeding 3,500 kg but not exceeding 4,536 kg, each Contracting Party may elect to apply either provisions of paragraph 2.2.(a) or paragraph 2.2.(b) depending on the vehicle classification systems used in the domestic legislation.

3. Definitions

For the purpose of this regulation, the following definitions apply:

- 3.1. "*Active driving possible mode*" means the vehicle mode when application of pressure to the accelerator pedal (or activation of an equivalent control) or release of the brake system will cause the electric power train to move the vehicle.
- 3.2. "*Aqueous electrolyte*" means an electrolyte based on water solvent for the compounds (e.g. acids, bases) providing conducting ions after its dissociation.
- 3.3. "*Automatic disconnect*" means a device that when triggered, conductively separates the electric energy sources from the rest of the high voltage circuit of the electric power train.
- 3.4. "*Breakout harness*" means connector wires that are connected for testing purposes to the REESS on the traction side of the automatic disconnect.
- 3.5. "*Cell*" means a single encased electrochemical unit containing one positive and one negative terminal, which exhibits a voltage differential across its two terminals and used as rechargeable energy storage device.
- 3.6. "*Conductive connection*" means the connection using connectors to an external power supply when the rechargeable energy storage system (REESS) is charged.
- 3.7. "*Connector*" means the device providing mechanical connection and disconnection of high voltage electrical conductors to a suitable mating component including its housing
- 3.8. "*Coupling system for charging the Rechargeable Electrical Energy Storage System (REESS)*" means the electrical circuit used for charging the REESS from an external electric power supply including the vehicle inlet.
- 3.9. "*C Rate*" of "*n C*" is defined as the constant current of the Tested-Device, which takes 1/n hours to charge or discharge the Tested-Device between 0 per cent SOC and 100 per cent SOC.
- 3.10. "*Direct contact*" means the contact of persons with high voltage live parts.
- 3.11. "*Electric energy conversion system*" means a system (e.g. fuel cell) that generates and provides electric energy for electrical propulsion.
- 3.12. "*Electric power train*" means the electrical circuits which includes the traction motor(s), and may also include the REESS, the electric energy conversion system, the electronic converters, the associated wiring harness and connectors, and the coupling system for charging the REESS.
- 3.13. "*Electrical chassis*" means a set made of conductive parts electrically linked together, whose electrical potential is taken as reference.
- 3.14. "*Electrical circuit*" means an assembly of connected high voltage live parts which is designed to be electrically energized in normal operation.
- 3.15. "*Electrical protection barrier*" means the part providing protection against any direct contact to the high voltage live parts.
- 3.16. "*Electrolyte leakage*" means the escape of electrolyte from the REESS in the form of liquid.

- 3.17. "*Electronic converter*" means a device capable of controlling and/or converting electric power for electrical propulsion.
- 3.18. "*Enclosure*" means the part enclosing the internal units and providing protection against any direct contact.
- 3.19. "*Explosion*" means the sudden release of energy sufficient to cause pressure waves and/or projectiles that may cause structural and/or physical damage to the surrounding of the Tested-Device.
- 3.20. "*Exposed conductive part*" means the conductive part which can be touched under the provisions of the protection degree IPXXB, and which is not normally energized, but which can become electrically energized under isolation failure conditions. This includes parts under a cover that can be removed without using tools.
- 3.21. "*External electric power supply*" means an alternating current (AC) or direct current (DC) electric power supply outside of the vehicle.
- 3.22. "*Fire*" means the emission of flames from a Tested-Device. Sparks and arcing shall not be considered as flames.
- 3.23. "*Flammable electrolyte*" means an electrolyte that contains substances classified as Class 3 "flammable liquid" under "UN Recommendations on the Transport of Dangerous Goods - Model Regulations (Revision 17 from June 2011), Volume I, Chapter 2.3"
- 3.24. "*High voltage*" means the classification of an electric component or circuit, if its working voltage is $> 60 \text{ V}$ and $\leq 1,500 \text{ V DC}$ or $> 30 \text{ V}$ and $\leq 1,000 \text{ V AC}$ root mean square (rms).
- 3.25. "*High voltage bus*" means the electrical circuit, including the coupling system for charging the REESS, that operates on high voltage. Where electrical circuits, that are galvanically connected to each other and fulfilling the specific voltage condition, only the components or parts of the electric circuit that operate on high voltage are classified as a high voltage bus.
- 3.26. "*Indirect contact*" means the contact of persons with exposed conductive parts.
- 3.27. "*Live parts*" means conductive part(s) intended to be electrically energized under normal operating conditions.
- 3.28. "*Luggage compartment*" means the space in the vehicle for luggage accommodation, bounded by the roof, hood, floor, side walls, as well as by the barrier and enclosure provided for protecting the occupants from direct contact with high voltage live parts, being separated from the passenger compartment by the front bulkhead or the rear bulk head.
- 3.29. "*Manufacturer*" means the person or body who is responsible to the approval authority for all aspects of the approval process and for ensuring conformity of production. It is not essential that the person or body is directly involved in all stages of the construction of the vehicle or component which is the subject of the approval process.
- 3.30. "*Non-aqueous electrolyte*" means an electrolyte not based on water as the solvent.
- 3.31. "*Normal operating conditions*" includes operating modes and conditions that can reasonably be encountered during typical operation of the vehicle

including driving at legally posted speeds, parking and standing in traffic, as well as, charging using chargers that are compatible with the specific charging ports installed on the vehicle. It does not include, conditions where the vehicle is damaged, either by a crash, road debris or vandalization, subjected to fire or water submersion, or in a state where service and or maintenance is needed or being performed.

- 3.32. "*On-board isolation resistance monitoring system*" means the device which monitors the isolation resistance between the high voltage buses and the electrical chassis.
- 3.33. "*Open-type traction battery*" means a type of battery requiring filling with liquid and generating hydrogen gas that is released into the atmosphere.
- 3.34. "*Passenger compartment*" means the space for occupant accommodation, bounded by the roof, floor, side walls, doors, window glass, front bulkhead and rear bulkhead, or rear gate, as well as by the electrical protection barriers and enclosures provided for protecting the occupants from direct contact with high voltage live parts.
- 3.35. "*Protection degree IPXXB*" means protection from contact with high voltage live parts provided by either an electrical protection barrier or an enclosure and tested using a Jointed Test Finger (IPXXB) as described in paragraph 6.1.3.
- 3.36. "*Protection degree IPXXD*" means protection from contact with high voltage live parts provided by either an electrical protection barrier or an enclosure and tested using a Test Wire (IPXXD) as described in paragraph 6.1.3.
- 3.37. "*Rechargeable Electrical Energy Storage System (REESS)*" means the rechargeable electric energy storage system that provides electric energy for electrical propulsion.

A battery whose primary use is to supply power for starting the engine and/or lighting and/or other vehicle auxiliaries systems is not considered as a REESS.

The REESS may include the necessary ancillary systems for physical support, thermal management, electronic controls and casing.

- 3.38. "*REESS subsystem*" means any assembly of REESS components which stores energy. A REESS subsystem may or may not include entire management system of the REESS.
- 3.39. "*Rupture*" means opening(s) through the casing of any functional cell assembly created or enlarged by an event, large enough for a 12 mm diameter test finger (IPXXB) to penetrate and make contact with live parts (see paragraphs 6.1.3., 6.1.6.2.4. and 8.1.3.)
- 3.40. "*Service disconnect*" means the device for deactivation of the electrical circuit when conducting checks and services of the REESS, fuel cell stack, etc.
- 3.41. "*Solid insulator*" means the insulating coating of wiring harnesses, provided in order to cover and prevent the high voltage live parts from any direct contact.
- 3.42. "*Specific voltage condition*" means the condition that the maximum voltage of a galvanically connected electrical circuit between a DC live part and any other live part (DC or AC) is ≤ 30 V AC (rms) and ≤ 60 V DC.

Note: When a DC live part of such an electrical circuit is connected to chassis and the specific voltage condition applies, the maximum voltage between any live part and the electrical chassis is ≤ 30 V AC (rms) and ≤ 60 V DC.

- 3.43. "*State of charge (SOC)*" means the available electrical charge in a Tested-Device expressed as a percentage of its rated capacity.
- 3.44. "*Tested-Device*" means either complete REESS or REESS subsystem that is subjected to the tests prescribed by this regulation.
- 3.45. "*Thermal event*" means the condition when the temperature within the REESS is significantly higher (as defined by the manufacturer) than the maximum operating temperature.
- 3.46. "*Thermal runaway*" means an uncontrolled increase of cell temperature caused by exothermic reactions inside the cell.
- 3.47. "*Thermal propagation*" means the sequential occurrence of thermal runaway within a battery system triggered by thermal runaway of a cell in that battery system.
- 3.48. "*Vehicle connector*" means the device which is inserted into the vehicle inlet to supply electric energy to the vehicle from an external electric power supply.
- 3.49. "*Vehicle inlet*" means the device on the externally chargeable vehicle into which the vehicle connector is inserted for the purpose of transferring electric energy from an external electric power supply.
- 3.50. "*Venting*" means the release of excessive internal pressure from cell or battery in a manner intended by design to preclude rupture or explosion.
- 3.51. "*Working voltage*" means the highest value of an electrical circuit voltage root-mean-square (rms), specified by the manufacturer, which may occur between any conductive parts in open circuit conditions or under normal operating condition. If the electrical circuit is divided by galvanic isolation, the working voltage is defined for each divided circuit, respectively.

4. General requirements

- 4.1. The vehicles prescribed in paragraph 2.2.(a) shall meet the requirements of paragraphs 5.1. and 5.2. using the test conditions and procedures in paragraph 6.1.
- 4.2. The REESS for the vehicles prescribed in paragraph 2.2.(a), regardless of its nominal voltage or working voltage, shall meet the requirements of paragraphs 5.4. and 5.5. using the test conditions and procedures in paragraph 6.2. The REESS shall be installed on the vehicles that meet the requirement of paragraph 5.3.
- 4.3. The vehicles prescribed in paragraph 2.2.(b) shall meet the requirements of paragraphs 7.1. using the test conditions and procedures in paragraph 8.1.
- 4.4. The REESS for the vehicles prescribed in paragraph 2.2.(b), regardless of its nominal voltage or working voltage, shall meet the requirements of paragraphs 7.3. and 7.4. using the test conditions and procedures in paragraph 8.2. The REESS shall be installed on the vehicles that meet the requirement of paragraph 7.2.

- 4.5. Each Contracting Party under the UN 1998 Agreement may maintain its existing national crash tests (e.g. frontal, side, rear, or rollover) and shall use the provisions of paragraph 5.2. for compliance.

5. Performance requirements

- 5.1. Requirements of a vehicle with regard to its electrical safety - in-use.

- 5.1.1. Protection against electric shock.

These electrical safety requirements apply to high voltage buses under conditions where they are not connected to the external electric power supply.

- 5.1.1.1. Protection against direct contact.

High voltage live parts shall comply with paragraphs 5.1.1.1.1. and 5.1.1.1.2. for protection against direct contact. Electrical protection barriers, enclosures, solid insulators and connectors shall not be opened, disassembled or removed without the use of tools.

However, connectors (including the vehicle inlet) are allowed to be separated without the use of tools, if they meet one or more of the following requirements:

- (a) They comply with paragraphs 5.1.1.1.1. and 5.1.1.1.2. when separated; or
- (b) They are provided with a locking mechanism (at least two distinct actions are needed to separate the connector from its mating component). Additionally, other components, not being part of the connector, shall be removable only with the use of tools in order to be able to separate the connector; or
- (c) The voltage of the live parts becomes equal or below 60V DC or equal or below 30V AC (rms) within 1 s after the connector is separated.

- 5.1.1.1.1. For high voltage live parts inside the passenger compartment or luggage compartment, the protection degree IPXXD shall be provided.

- 5.1.1.1.2. For high voltage live parts in areas other than the passenger compartment or luggage compartment, the protection degree IPXXB shall be provided.

- 5.1.1.1.3. Service disconnect.

For a high voltage service disconnect which can be opened, disassembled or removed without tools, protection degree IPXXB shall be satisfied when it is opened, disassembled or removed without tools.

- 5.1.1.1.4. Marking.

- 5.1.1.1.4.1. The symbol shown in Figure 1 shall be present on or near the REESS having high voltage capability. The symbol background shall be yellow, the bordering and the arrow shall be black.

This requirement shall also apply to a REESS which is part of a galvanically connected electrical circuit where the specific voltage condition is not fulfilled, independent of the maximum voltage of the REESS.

Figure 1
Marking of high voltage equipment



- 5.1.1.1.4.2. The symbol shall be visible on enclosures and electrical protection barriers, which, when removed, expose live parts of high voltage circuits. This provision is optional to any connectors for high voltage buses. This provision shall not apply to the case where electrical protection barriers or enclosures cannot be physically accessed, opened, or removed; unless other vehicle components are removed with the use of tools.
- 5.1.1.1.4.3. Cables for high voltage buses which are not located within enclosures shall be identified by having an outer covering with the colour orange.
- 5.1.1.2. Protection against indirect contact.
- 5.1.1.2.1. For protection against electric shock which could arise from indirect contact, the exposed conductive parts, such as the conductive electrical protection barrier and enclosure, shall be conductively connected and secured to the electrical chassis with electrical wire or ground cable, by welding, or by connection using bolts, etc. so that no dangerous potentials are produced.
- 5.1.1.2.2. The resistance between all exposed conductive parts and the electrical chassis shall be lower than 0.1Ω when there is current flow of at least 0.2 A .
- The resistance between any two simultaneously reachable exposed conductive parts of the electrical protection barriers that are less than 2.5 m from each other shall not exceed 0.2Ω . This resistance may be calculated using the separately measured resistances of the relevant parts of electric path.
- This requirement is satisfied if the connection has been established by welding. In case of doubts or the connection is established by other means than welding, a measurement shall be made by using one of the test procedures described in paragraph 6.1.4.
- 5.1.1.2.3. In the case of motor vehicles which are intended to be connected to the grounded external electric power supply through the conductive connection, a device to enable the conductive connection of the electrical chassis to the earth ground for the external electric power supply shall be provided.
- The device shall enable connection to the earth ground before exterior voltage is applied to the vehicle and retain the connection until after the exterior voltage is removed from the vehicle.
- Compliance to this requirement may be demonstrated either by using the connector specified by the car manufacturer, by visual inspection or drawings.
- 5.1.1.2.4. Isolation resistance.
- This paragraph shall not apply to electrical circuits that are galvanically connected to each other, where the DC part of these circuits is connected to the electrical chassis and the specific voltage condition is fulfilled.

- 5.1.1.2.4.1. Electric power train consisting of separate Direct Current or Alternating Current buses.

If AC high voltage buses and DC high voltage buses are conductively isolated from each other, isolation resistance between the high voltage bus and the electrical chassis shall have a minimum value of 100 Ω/V of the working voltage for DC buses, and a minimum value of 500 Ω/V of the working voltage for AC buses.

The measurement shall be conducted according to 6.1.1.

- 5.1.1.2.4.2. Electric power train consisting of combined DC- and AC-buses.

If AC high voltage buses and DC high voltage buses are conductively connected, isolation resistance between the high voltage bus and the electrical chassis shall have a minimum value of 500 Ω/V of the working voltage.

However, if all AC high voltage buses are protected by one of the two following measures, isolation resistance between the high voltage bus and the electrical chassis shall have a minimum value of 100 Ω/V of the working voltage:

- (a) At least two or more layers of solid insulators, electrical protection barriers or enclosures that meet the requirement in paragraph 5.1.1.1. independently, for example wiring harness, or
- (b) Mechanically robust protections that have sufficient durability over vehicle service life such as motor housings, electronic converter cases or connectors.

The isolation resistance between the high voltage bus and the electrical chassis may be demonstrated by calculation, measurement or a combination of both.

The measurement shall be conducted according to paragraph 6.1.1.

- 5.1.1.2.4.3. Fuel cell vehicles.

In fuel cell vehicles, DC high voltage buses shall have an on-board isolation resistance monitoring system together with a warning to the driver if the isolation resistance drops below the minimum required value of 100 Ω/V . The function of the on-board isolation resistance monitoring system shall be confirmed as described in paragraph 6.1.2.

The isolation resistance between the high voltage bus of the coupling system for charging the REESS, which is not energized in conditions other than that during the charging of the REESS, and the electrical chassis need not to be monitored.

- 5.1.1.2.4.4. Isolation resistance requirement for the coupling system for charging the REESS.

For the vehicle inlet intended to be conductively connected to the external AC electric power supply and the electrical circuit that is conductively connected to the vehicle inlet during charging the REESS, the isolation resistance between the high voltage bus and the electrical chassis shall comply with the requirements of paragraph 5.1.1.2.4.1. when the vehicle connector is disconnected and the isolation resistance is measured at the high voltage live parts (contacts) of the vehicle inlet. During the measurement, the REESS may be disconnected.

The measurement shall be conducted according to paragraph 6.1.1.

- 5.1.1.3. Protection against water effects.
- The vehicles shall maintain isolation resistance after exposure to water (e.g. washing, driving through standing water). This paragraph shall not apply to electrical circuits that are galvanically connected to each other, where the DC part of these circuits is connected to the electrical chassis and the specific voltage condition is fulfilled.
- 5.1.1.3.1. The vehicle manufacturer can choose to comply with requirements specified in paragraph 5.1.1.3.2. or those specified in paragraph 5.1.1.3.3.
- 5.1.1.3.2. The vehicle manufacturers shall provide evidence and/or documentation to the regulatory or testing entity as applicable on how the electrical design or the components of the vehicle located outside the passenger compartment or externally attached, after water exposure remain safe and comply with the requirements described in Annex 2. If the evidence and/or documentation provided is not satisfactory the regulatory or testing entity as applicable shall require the manufacturer to perform a physical component test based on the same specifications as those described in Annex 2.
- 5.1.1.3.3. If the test procedures specified in paragraph 6.1.5. are performed, just after each exposure, and with the vehicle still wet, the vehicle shall then comply with isolation resistance test given in paragraph 6.1.1., and the isolation resistance requirements given in paragraph 5.1.1.2.4. shall be met. In addition, after a 24 hour pause, the isolation resistance test specified in paragraph 6.1.1. shall again be performed, and the isolation resistance requirements given in paragraph 5.1.1.2.4. shall be met.
- 5.1.1.3.4. Each Contracting Party may elect to adopt the following requirement as an alternative to the requirements in paragraph 5.1.1.3.1.
- If an isolation resistance monitoring system is provided, and the isolation resistance less than the requirements given in paragraph 5.1.1.2.4. is detected, a warning shall be indicated to the driver. The function of the on-board isolation resistance monitoring system shall be confirmed as described in paragraph 6.1.2.
- 5.1.2. Functional safety.
- 5.1.2.1. At least a momentary indication shall be given to the driver each time when the vehicle is first placed in "active driving possible mode" after manual activation of the propulsion system.
- However, this provision does not apply under conditions where an internal combustion engine provides directly or indirectly the vehicle's propulsion power upon start up.
- 5.1.2.2. When leaving the vehicle, the driver shall be informed by a signal (e.g. optical or audible signal) if the vehicle is still in the active driving possible mode.
- 5.1.2.3. The state of the drive direction control unit shall be identified to the driver.
- 5.1.2.4. If the REESS can be externally charged, vehicle movement by its own propulsion system shall be impossible as long as the vehicle connector is physically connected to the vehicle inlet.

This requirement shall be demonstrated by using the vehicle connector specified by the vehicle manufacturer.

5.2. Requirements of a vehicle with regard to its electrical safety - post-crash

5.2.1. General principle

The requirements of paragraph 5.2.2. shall be checked in accordance with the methods set out in paragraph 6.1.6.

These requirements can be met by a separate crash test from that for the evaluation of occupant protection performance under the relevant crash regulations. This is only possible, if the electrical components do not influence the occupant protection performance.

5.2.2. Protection against electric shock.

After the crash test, at least one of the four criteria specified in paragraphs 5.2.2.1.to 5.2.2.4. shall be met.

If the vehicle has an automatic disconnect function or device(s) that conductively divide the electric power train circuit during driving condition, at least one of the following criteria shall apply to the disconnected circuit or to each divided circuit individually after the disconnect function is activated.

However, criteria defined in paragraph 5.2.2.4. shall not apply if more than a single potential of a part of the high voltage bus are not protected under the conditions of protection degree IPXXB.

In the case that the crash test is performed under the condition that part(s) of the high voltage system are not energized and with the exception of any coupling system for charging the REESS which is not energized during driving condition, the protection against electric shock shall be proved by either paragraph 5.2.2.3. or paragraph 5.2.2.4. for the relevant part(s).

5.2.2.1. Absence of high voltage.

The voltages V_b , V_1 and V_2 of the high voltage buses shall be equal or less than 30 V AC (rms) or 60 V DC within 60 s after the impact when measured in accordance with paragraph 6.1.6.2.2.

5.2.2.2. Low electrical energy.

The Total Energy (TE) of unidirectional single impulse currents in the form of rectangular and sinusoidal impulses or capacitor discharges from high voltage electrical components shall be less than 0.2 J when measured and calculated in accordance with formula (a) of paragraph 6.1.6.2.3.

Alternatively, the TE may be calculated by the measured voltage V_b of the high voltage bus and the capacitance of the X-capacitors (C_x) specified by the manufacturer according to formula (b) of paragraph 6.1.6.2.3.

The energy stored in the Y-capacitors (TE_{y1} , TE_{y2}) shall also be less than 0.2 J. This shall be calculated by measuring the voltages V_1 and V_2 of the high voltage buses and the electrical chassis, and the capacitance of the Y-capacitors specified by the manufacturer according to formula (c) of paragraph 6.1.6.2.3.

5.2.2.3. Physical protection.

For protection against direct contact with high voltage live parts, the protection degree IPXXB shall be provided.

The assessment shall be conducted in accordance with paragraph 6.1.6.2.4.

In addition, for protection against electric shock which could arise from indirect contact, the resistance between all exposed conductive parts of electrical protection barriers/enclosures and electrical chassis shall be lower than 0.1Ω and the resistance between any two simultaneously reachable exposed conductive parts of electrical protection barriers/enclosures that are less than 2.5 m from each other shall be less than 0.2Ω when there is current flow of at least 0.2 A.

These requirements are satisfied if the connection has been established by welding. In case of doubt or the connection is established by mean other than welding, measurements shall be made by using one of the test procedures described in paragraph 6.1.4.

Each Contracting Party under the UN 1998 Agreement may additionally apply the following requirement:

The voltage between all exposed conductive parts of electrical protection barriers/enclosures and electrical chassis and the voltage between any two simultaneously reachable exposed conductive parts of electrical protection barriers/enclosures that are less than 2.5 m from each other shall be less than or equal to 30 V AC (rms) or 60 V DC as measured in accordance with paragraph 6.1.6.2.4.1.

5.2.2.4. Isolation resistance.

The criteria specified in the paragraphs 5.2.2.4.1. and 5.2.2.4.2. below shall be met.

The measurement shall be conducted in accordance with paragraph 6.1.6.2.5.

5.2.2.4.1. Electrical power train consisting of separate DC- and AC-buses

If the AC high voltage buses and the DC high voltage buses are conductively isolated from each other, isolation resistance between the high voltage bus and the electrical chassis shall have a minimum value of $100 \Omega/V$ of the working voltage for DC buses, and a minimum value of $500 \Omega/V$ of the working voltage for AC buses.

5.2.2.4.2. Electrical power train consisting of combined DC- and AC-buses.

If the AC high voltage buses and the DC high voltage buses are conductively connected, they shall meet one of the following requirements:

- (a) Isolation resistance between the high voltage bus and the electrical chassis shall have a minimum value of $500 \Omega/V$ of the working voltage;
- (b) Isolation resistance between the high voltage bus and the electrical chassis shall have a minimum value of $100 \Omega/V$ of the working voltage and the AC bus meets the physical protection as described in paragraph 5.2.2.3;
- (c) Isolation resistance between the high voltage bus and the electrical chassis shall have a minimum value of $100 \Omega/V$ of the working voltage and the AC bus meets the absence of high voltage as described in paragraph 5.2.2.1.

- 5.3. Requirements with regard to installation and functionality of REESS in a vehicle.
- 5.3.1. Installation of REESS on a vehicle.
For installation of REESS on a vehicle, the requirement of either paragraph 5.3.1.1. or paragraph 5.3.1.2. shall be satisfied. In addition, the requirement of 5.3.1.3 shall be satisfied.
- 5.3.1.1. The REESS shall comply with the respective requirements of paragraphs 5.4. and 5.5., taking account of the installed conditions on a specific type of vehicle.
- 5.3.1.2. For a REESS which satisfies the requirements of paragraphs 5.4. and 5.5. independently from the type of vehicles, the REESS shall be installed on the vehicle in accordance with the instructions provided by the manufacturer of the REESS.
- 5.3.1.3. The components of the REESS installation shall be adequately protected by parts of the frame or bodywork against contact with possible obstacles on the ground. Such protection shall not be required if the components beneath the vehicle are further from the ground than the part of the frame or bodywork in front of them.
- 5.3.2. Warning in the event of operational failure of vehicle controls that manage REESS safe operation.
The vehicle shall provide a warning to the driver when the vehicle is in active driving possible mode in the event of operational failure of the vehicle controls that manage the safe operation of the REESS. Vehicle manufacturers shall make available, at the request of the regulatory or testing entity as applicable with its necessity, the following documentation explaining safety performance of the system level or sub-system level of the vehicle:
- 5.3.2.1. A system diagram that identifies all the vehicle controls that manage REESS operations. The diagram must identify what components are used to generate a warning due to operational failure of vehicle controls to conduct one or more basic operations.
- 5.3.2.2. A written explanation describing the basic operation of the vehicle controls that manage REESS operation. The explanation must identify the components of the vehicle control system, provide description of their functions and capability to manage the REESS, and provide a logic diagram and description of conditions that would lead to triggering of the warning.
In case of optical warning, the tell-tale shall, when illuminated, be sufficiently bright to be visible to the driver under both daylight and night-time driving conditions, when the driver has adapted to the ambient roadway light conditions.
This tell-tale shall be activated as a check of lamp function either when the propulsion system is turned to the "On" position, or when the propulsion system is in a position between "On" and "Start" that is designated by the manufacturer as a check position. This requirement does not apply to the tell-tale or text shown in a common space.
- 5.3.3. Warning in the case of a thermal event within the REESS.
The vehicle shall provide a warning to the driver in the case of a thermal event in the REESS (as specified by the manufacturer) when the vehicle is in

active driving possible mode. Vehicle manufacturers shall make available, at the request of the regulatory or testing entity as applicable with its necessity, the following documentation explaining safety performance of the system level or sub-system level of the vehicle:

5.3.3.1. The parameters and associated threshold levels that are used to indicate a thermal event (e.g. temperature, temperature rise rate, SOC level, voltage drop, electrical current, etc.) to trigger the warning.

5.3.3.2. A system diagram and written explanation describing the sensors and operation of the vehicle controls to manage the REESS in the event of a thermal event.

In case of optical warning, the tell-tale shall, when illuminated, be sufficiently bright to be visible to the driver under both daylight and night-time driving conditions, when the driver has adapted to the ambient roadway light conditions.

This warning tell-tale shall be activated as a check of lamp function either when the propulsion system is turned to the "On" position, or when the propulsion system is in a position between "On" and "Start" that is designated by the manufacturer as a check position. This requirement does not apply to the optical signal or text shown in a common space.

5.3.4. Warning in the event of low energy content of REESS.

For BEVs (vehicles in which propulsion system are powered only by a REESS), a warning to the driver in the event of low REESS state of charge shall be provided. Based on engineering judgment, the manufacturer shall determine the necessary level of REESS energy remaining, when the driver warning is first provided.

In case of optical warning, the tell-tale shall, when illuminated, be sufficiently bright to be visible to the driver under both daylight and night-time driving conditions, when the driver has adapted to the ambient roadway light conditions.

5.4. Requirements with regard to the safety of REESS in-use.

5.4.1. General principle.

The requirements of paragraphs 5.4.2. to 5.4.12. shall be checked in accordance with the methods set out in paragraph 6.2.

5.4.2. Vibration.

The test shall be conducted in accordance with paragraph 6.2.2.

During the test, there shall be no evidence of rupture (applicable to high voltage REESS only), electrolyte leakage, venting (for REESS other than open-type traction battery), fire or explosion.

The evidence of electrolyte leakage shall be verified by visual inspection without disassembling any part of the Tested-Device. An appropriate technique shall, if necessary, be used in order to confirm if there is any electrolyte leakage from the REESS resulting from the test. The evidence of venting shall be verified by visual inspection without disassembling any part of the Tested-Device.

For a high voltage REESS, the isolation resistance measured after the test in accordance with paragraph 6.1.1. shall not be less than 100 Ω/V .

5.4.3. Thermal shock and cycling.

The test shall be conducted in accordance with paragraph 6.2.3.

During the test, there shall be no evidence of electrolyte leakage, rupture (applicable to high voltage REESS only), venting (for REESS other than open-type traction battery), fire or explosion.

The evidence of electrolyte leakage shall be verified by visual inspection without disassembling any part of the Tested-Device. An appropriate technique shall, if necessary, be used in order to confirm if there is any electrolyte leakage from the REESS resulting from the test. The evidence of venting shall be verified by visual inspection without disassembling any part of the Tested-Device.

For a high voltage REESS, the isolation resistance measured after the test in accordance with paragraph 6.1.1. shall not be less than 100 Ω/V .

5.4.4. Fire resistance.

The test shall be conducted in accordance with paragraph 6.2.4.

This test is required for REESS containing flammable electrolyte.

This test is not required when the REESS as installed in the vehicle, is mounted such that the lowest surface of the casing of the REESS is more than 1.5 m above the ground. At the choice of the manufacturer, this test may be performed where the lower surface of the REESS's is higher than 1.5 m above the ground. The test shall be carried out on one test sample.

During the test, the Tested-Device shall exhibit no evidence of explosion.

5.4.5. External short circuit protection.

The test shall be conducted in accordance with paragraph 6.2.5.

During the test there shall be no evidence of; electrolyte leakage, rupture (applicable to high voltage REESS only), venting (for REESS other than open-type traction battery), fire or explosion.

The evidence of electrolyte leakage shall be verified by visual inspection without disassembling any part of the Tested-Device. An appropriate technique shall, if necessary, be used in order to confirm if there is any electrolyte leakage from the REESS resulting from the test. The evidence of venting shall be verified by visual inspection without disassembling any part of the Tested Device.

The short circuit protection control of the REESS shall terminate the short circuit current, or the temperature measured on the casing of the Tested-Device or the REESS shall be stabilized, such that the temperature gradient varies by less than 4 °C through 2 hours after introducing the short circuit.

For a high voltage REESS, the isolation resistance measured after the test in accordance with paragraph 6.1.1. shall not be less than 100 Ω/V .

5.4.6. Overcharge protection.

The test shall be conducted in accordance with paragraph 6.2.6.

During the test there shall be no evidence of electrolyte leakage, rupture (applicable to high voltage REESS only), venting (for REESS other than open-type traction battery), fire or explosion.

The evidence of electrolyte leakage shall be verified by visual inspection without disassembling any part of the Tested-Device. An appropriate technique shall, if necessary, be used in order to confirm if there is any electrolyte leakage from the REESS resulting from the test. The evidence of venting shall be verified by visual inspection without disassembling any part of the Tested Device.

For a high voltage REESS, the isolation resistance measured after the test in accordance with paragraph 6.1.1. shall not be less than 100 Ω/V .

5.4.7. Over-discharge protection.

The test shall be conducted in accordance with paragraph 6.2.7.

During the test there shall be no evidence of; electrolyte leakage, rupture (applicable to high voltage REESS only), venting (for REESS other than open-type traction battery), fire or explosion.

The evidence of electrolyte leakage shall be verified by visual inspection without disassembling any part of the Tested-Device. An appropriate technique shall, if necessary, be used in order to confirm if there is any electrolyte leakage from the REESS resulting from the test. The evidence of venting shall be verified by visual inspection without disassembling any part of the Tested-Device.

For a high voltage REESS, the isolation resistance measured after the test in accordance with paragraph 6.1.1. shall not be less than 100 Ω/V .

5.4.8. Over-temperature protection.

The test shall be conducted in accordance with paragraph 6.2.8.

During the test there shall be no evidence of; electrolyte leakage, rupture (applicable to high voltage REESS only), venting (for REESS other than open-type traction battery), fire or explosion.

The evidence of electrolyte leakage shall be verified by visual inspection without disassembling any part of the Tested-Device. An appropriate technique shall, if necessary, be used in order to confirm if there is any electrolyte leakage from the REESS resulting from the test. The evidence of venting shall be verified by visual inspection without disassembling any part of the Tested-Device.

For a high voltage REESS, the isolation resistance measured after the test in accordance with paragraph 6.1.1. shall not be less than 100 Ω/V .

5.4.9. Overcurrent protection.

The test shall be conducted in accordance with paragraph 6.2.9.

During the test there shall be no evidence of electrolyte leakage, rupture (applicable to high voltage REESS only), venting (for REESS other than open-type traction battery), fire or explosion.

The evidence of electrolyte leakage shall be verified by visual inspection without disassembling any part of the Tested-Device. An appropriate technique shall, if necessary, be used in order to confirm if there is any electrolyte leakage from the REESS resulting from the test. The evidence of venting shall be verified by visual inspection without disassembling any part of the Tested-Device.

The overcurrent protection control of the REESS shall terminate charging or the temperature measured on the casing of the REESS shall be stabilized, such that the temperature gradient varies by less than 4 °C through 2 hours after the maximum overcurrent charging level is reached.

For a high voltage REESS, the isolation resistance measured after the test in accordance with paragraph 6.1.1. shall not be less than 100 Ω/V.

5.4.10. Low-temperature protection.

Vehicle manufacturers must make available, at the request of the regulatory or testing entity as applicable with its necessity, the following documentations explaining safety performance of the system level or sub-system level of the vehicle to demonstrate that the vehicle monitors and appropriately controls REESS operations at low temperatures at the safety boundary limits of the REESS:

- (a) A system diagram;
- (b) Written explanation on the lower boundary temperature for safe operation of REESS;
- (c) Method of detecting REESS temperature;
- (d) Action taken when the REESS temperature is at or lower than the lower boundary for safe operation of the REESS.

5.4.11. Management of gases emitted from REESS.

5.4.11.1. Under vehicle operation including the operation with a failure, the vehicle occupants shall not be exposed to any hazardous environment caused by emissions from REESS.

5.4.11.2. For the open-type traction battery, requirement of paragraph 5.4.11.1. shall be verified by following test procedure.

5.4.11.2.1. The test shall be conducted following the method described in Annex 1 of this regulation. The hydrogen sampling and analysis shall be the ones prescribed. Other analysis methods can be approved if it is proven that they give equivalent results.

5.4.11.2.2. During a normal charge procedure in the conditions given in Annex 1, hydrogen emissions shall be below 125 g during 5 hours, or below 25 x t₂ g during t₂ (in h) where t₂ is the time of overcharging at constant current.

5.4.11.2.3. During a charge carried out by a charger presenting a failure (conditions given in Annex 1), hydrogen emissions shall be below 42 g. Furthermore, the charger shall limit this possible failure to 30 minutes.

5.4.11.3. For REESS other than open-type traction battery, the requirement of paragraph 5.4.11.1. is deemed to be satisfied, if all requirements of the following tests are met: para. 6.2.2. (vibration), para. 6.2.3. (thermal shock and cycling), para. 6.2.5. (external short circuit protection), para. 6.2.6. (overcharge protection), para. 6.2.7. (over-discharge protection), para. 6.2.8. (over-temperature protection) and para. 6.2.9. (overcurrent protection).

5.4.12. Thermal propagation.

For the vehicles equipped with a REESS containing flammable electrolyte, the vehicle occupants shall not be exposed to any hazardous environment caused by thermal propagation which is triggered by an internal short circuit

leading to a single cell thermal runaway. To ensure this, the requirements of paragraphs 5.4.12.1. and 5.4.12.2. shall be satisfied.²

- 5.4.12.1. The vehicle shall provide an advance warning indication to allow egress or 5 minutes prior to the presence of a hazardous situation inside the passenger compartment caused by thermal propagation which is triggered by an internal short circuit leading to a single cell thermal runaway such as fire, explosion or smoke. This requirement is deemed to be satisfied if the thermal propagation does not lead to a hazardous situation for the vehicle occupants. This warning shall have characteristics in accordance with paragraph 5.3.3.2. The vehicle manufacturer shall make available, at the request of the regulatory or testing entity as applicable with its necessity, the following documentation explaining safety performance of the system level or sub-system level of the vehicle:
 - 5.4.12.1.1. The parameters (for example, temperature, voltage or electrical current) which trigger the warning indication.
 - 5.4.12.1.2. Description of the warning system.
- 5.4.12.2. The vehicle shall have functions or characteristics in the cell, REESS or vehicle intended to protect vehicle occupants (as described in paragraph 5.4.12.) in conditions caused by thermal propagation which is triggered by an internal short circuit leading to a single cell thermal runaway. Vehicle manufacturers shall make available, at the request of the regulatory or testing entity as applicable with its necessity, the following documentation explaining safety performance of the system level or sub-system level of the vehicle (see also paragraph 196 in Part 1, section E):
 - 5.4.12.2.1. A risk reduction analysis using appropriate industry standard methodology (for example, IEC 61508, MIL-STD 882E, ISO 26262, AIAG DFMEA, fault analysis as in SAE J2929, or similar), which documents the risk to vehicle occupants caused by thermal propagation which is triggered by an internal short circuit leading to a single cell thermal runaway and documents the reduction of risk resulting from implementation of the identified risk mitigation functions or characteristics.
 - 5.4.12.2.2. A system diagram of all relevant physical systems and components. Relevant systems and components are those which contribute to protection of vehicle occupants from hazardous effects caused by thermal propagation triggered by a single cell thermal runaway.
 - 5.4.12.2.3. A diagram showing the functional operation of the relevant systems and components, identifying all risk mitigation functions or characteristics.
 - 5.4.12.2.4. For each identified risk mitigation function or characteristic:
 - 5.4.12.2.4.1. A description of its operation strategy;
 - 5.4.12.2.4.2. Identification of the physical system or component which implements the function;

² In regions applying type-approval testing the manufacturer will be accountable for the verity and integrity of documentation submitted, assuming full responsibility for the safety of occupants against adverse effects arising from thermal propagation caused by internal short circuit. In regions applying self-certification responsibility is automatically borne by the manufacturer.

5.4.12.2.4.3. One or more of the following engineering documents relevant to the manufacturers design which demonstrates the effectiveness of the risk mitigation function:

- (a) Tests performed including procedure used and conditions and resulting data;
- (b) Analysis or validated simulation methodology and resulting data.

5.5. Requirements with regard to the safety of REESS – post-crash.

If any vehicle crash test under this regulation is conducted, the requirements of paragraphs 5.5.1.1. to 5.5.1.3. shall be satisfied.

These requirements can be met by a separate crash test from that for the evaluation of occupant protection performance under the relevant crash regulations. This is only possible, if the electrical components do not influence the occupant protection performance.

However, if the REESS satisfies the requirements of paragraph 5.5.2., the requirements of this paragraph are considered as satisfied for the respective direction of the crash test.

5.5.1. Vehicle based test

5.5.1.1. Electrolyte leakage.

5.5.1.1.1. In case of aqueous electrolyte REESS.

For a period from the impact until 60 minutes after the impact, there shall be no electrolyte leakage from the REESS into the passenger compartment and no more than 7 per cent by volume of the REESS electrolyte with a maximum of 5.0 l leaked from the REESS to the outside of the passenger compartment. The leaked amount of electrolyte can be measured by usual techniques of determination of liquid volumes after its collection. For containers containing Stoddard, coloured coolant and electrolyte, the fluids shall be allowed to separate by specific gravity then measured.

5.5.1.1.2. In case of non-aqueous electrolyte REESS.

For a period from the impact until 60 minutes after the impact, there shall be no liquid electrolyte leakage from the REESS into the passenger compartment, luggage compartment and no liquid electrolyte leakage to outside the vehicle. This requirement shall be verified by visual inspection without disassembling any part of the vehicle.

5.5.1.2. REESS retention.

REESS shall remain attached to the vehicle by at least one component anchorage, bracket, or any structure that transfers loads from REESS to the vehicle structure, and REESS located outside the passenger compartment shall not enter the passenger compartment.

5.5.1.3. Fire hazard.

For a period of 1 hour after the crash test, there shall be no evidence of fire or explosion of the REESS.

5.5.2. REESS-component based test.

5.5.2.1. Mechanical impact.

At the choice of the manufacturer, the REESS shall satisfy either the requirements of paragraph 5.5.1. or paragraph 5.5.2.

If the vehicle complies with the requirements of paragraph 5.5.1., the REESS of the vehicle is considered to be in compliance with this paragraph 5.5.2.1.

The approval of a REESS tested under paragraph 5.5.1. shall be limited to the specific vehicle type.

5.5.2.1.1. Mechanical shock.

The test shall be conducted in accordance with paragraph 6.2.10.

During the test, there shall be no evidence of electrolyte leakage, fire or explosion.

The evidence of electrolyte leakage shall be verified by visual inspection without disassembling any part of the Tested-Device. An appropriate technique shall, if necessary, be used in order to confirm if there is any electrolyte leakage from the REESS resulting from the test.

An appropriate coating, if necessary, may be applied to the physical protection (casing) in order to confirm if there is any electrolyte leakage from the REESS resulting from the test. Unless the manufacturer provides a means to differentiate between the leakage of different liquids, all liquid leakage shall be considered as the electrolyte.

After the test, the Tested-Device shall be retained by its mounting and its components shall remain inside its boundaries.

For a high voltage REESS, the isolation resistance of the Tested-Device shall ensure at least 100 Ω/V for the whole REESS measured after the test in accordance with paragraph 6.1.1., or the protection IPXXB shall be fulfilled for the Tested-Device when assessed in accordance with paragraph 6.1.6.2.4.

5.5.2.1.2. Mechanical integrity.

The test shall be conducted in accordance with paragraph 6.2.11.

The REESS certified according to this paragraph shall be mounted in a position which is between the two planes; (a) a vertical plane perpendicular to the centre line of the vehicle located 420 mm rearward from the front edge of the vehicle, and (b) a vertical plane perpendicular to the centre line of the vehicle located 300 mm forward from the rear edge of the vehicle.

The crush force specified in paragraph 6.2.11.3.2.1. may be replaced with the value declared by the manufacturer, where the crush force shall be documented in the relevant administration document as a mounting restriction, which shall also be referred to in compliance assessments for the vehicle. In this case, the vehicle manufacture who uses such REESS shall demonstrate that the contact force to the REESS will not exceed the figure declared by the REESS manufacturer. Such force shall be determined by the vehicle manufacturer using test data obtained from either actual or simulated crash tests as specified in the applicable crash regulations in relevant impact directions.

Manufacturers may use forces derived from data obtained from alternative crash test procedures, but these forces shall be equal to or greater than the forces that would result from using data in accordance with the applicable crash regulations.

During the test, there shall be no evidence of electrolyte leakage, fire or explosion.

The evidence of electrolyte leakage shall be verified by visual inspection without disassembling any part of the Tested-Device. An appropriate technique shall, if necessary, be used in order to confirm if there is any electrolyte leakage from the REESS resulting from the test.

An appropriate coating, if necessary, may be applied to the physical protection (casing) in order to confirm if there is any electrolyte leakage from the REESS resulting from the test. Unless the manufacturer provides a means to differentiate between the leakage of different liquids, all liquid leakage shall be considered as the electrolyte.

For a high voltage REESS, the isolation resistance of the Tested-Device shall ensure at least 100 Ω/V for the whole REESS measured in accordance with paragraph 6.1.1., or the protection IPXXB shall be fulfilled for the Tested-Device when assessed in accordance with paragraph 6.1.6.2.4.

6. Test procedures

6.1. Test procedures for electrical safety.

6.1.1. Isolation resistance measurement method.

6.1.1.1. General.

The isolation resistance for each high voltage bus of the vehicle is measured or shall be determined by calculating the measurement values of each part or component unit of a high voltage bus.

6.1.1.2. Measurement method.

The isolation resistance measurement is conducted by selecting an appropriate measurement method from among those listed in paragraphs 6.1.1.2.1. to 6.1.1.2.2., depending on the electrical charge of the live parts or the isolation resistance.

Megohmmeter or oscilloscope measurements are appropriate alternatives to the procedure described below for measuring isolation resistance. In this case, it may be necessary to deactivate the on-board isolation resistance monitoring system.

The range of the electrical circuit to be measured is clarified in advance, using electrical circuit diagrams. If the high voltage buses are conductively isolated from each other, isolation resistance shall be measured for each electrical circuit.

If the operating voltage of the Tested-Device (V_b , Figure 2) cannot be measured (e.g. due to disconnection of the electric circuit caused by main contactors or fuse operation), the test may be performed with a modified Test-Device to allow measurement of the internal voltages (upstream the main contactors).

Moreover, modifications necessary for measuring the isolation resistance may be carried out, such as removal of the cover in order to reach the live parts, drawing of measurement lines and change in software.

In cases where the measured values are not stable due to the operation of the on-board isolation resistance monitoring system, necessary modifications for conducting the measurement may be carried out by stopping the operation of the device concerned or by removing it. Furthermore, when the device is removed, a set of drawings will be used to prove that the isolation resistance between the live parts and the electrical chassis remains unchanged.

These modifications shall not influence the test results.

Utmost care shall be exercised to avoid short circuit and electric shock since this confirmation might require direct operations of the high-voltage circuit.

6.1.1.2.1. Measurement method using DC voltage from external sources.

6.1.1.2.1.1. Measurement instrument.

An isolation resistance test instrument capable of applying a DC voltage higher than the working voltage of the high voltage bus shall be used.

6.1.1.2.1.2. Measurement method.

An isolation resistance test instrument is connected between the live parts and the electrical chassis. The isolation resistance is subsequently measured by applying a DC voltage at least half of the working voltage of the high voltage bus.

If the system has several voltage ranges (e.g. because of boost converter) in conductively connected circuit and some of the components cannot withstand the working voltage of the entire circuit, the isolation resistance between those components and the electrical chassis can be measured separately by applying at least half of their own working voltage with those components disconnected.

6.1.1.2.2. Measurement method using the vehicle's own REESS as DC voltage source.

6.1.1.2.2.1. Test vehicle conditions.

The high voltage-bus is energized by the vehicle's own REESS and/or energy conversion system and the voltage level of the REESS and/or energy conversion system throughout the test shall be at least the nominal operating voltage as specified by the vehicle manufacturer.

6.1.1.2.2.2. Measurement instrument.

The voltmeter used in this test shall measure DC values and have an internal resistance of at least 10 M Ω .

6.1.1.2.2.3. Measurement method.

6.1.1.2.2.3.1. First step.

The voltage is measured as shown in Figure 2 and the high voltage bus voltage (V_b) is recorded. V_b shall be equal to or greater than the nominal operating voltage of the REESS and/or energy conversion system as specified by the vehicle manufacturer.

Figure 2
Measurement of V_b , V_1 , V_2

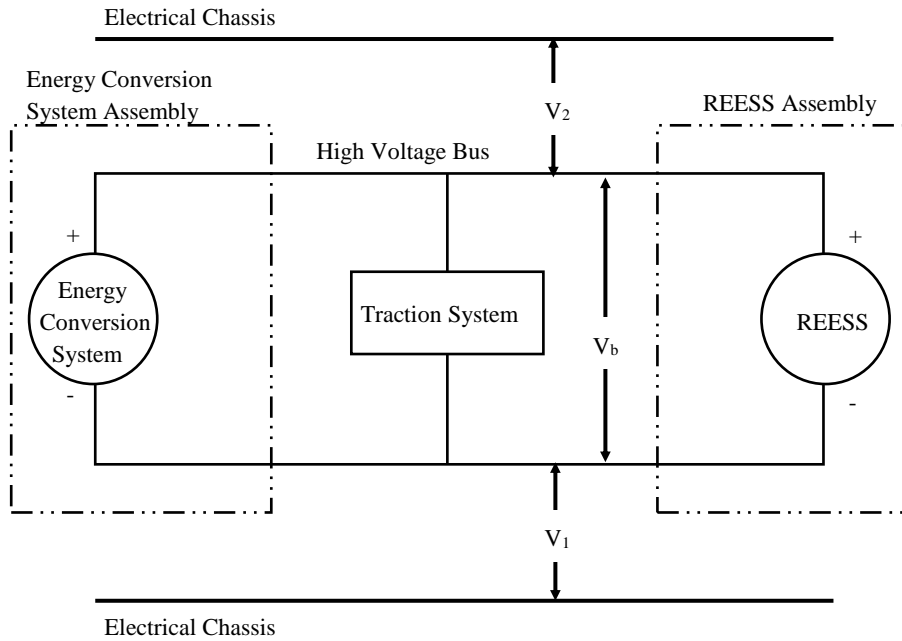

6.1.1.2.2.3.2. Second step.

The voltage (V_1) between the negative side of the high voltage bus and the electrical chassis is measured and recorded (see Figure 2).

6.1.1.2.2.3.3. Third step.

The voltage (V_2) between the positive side of the high voltage bus and the electrical chassis is measured and recorded (see Figure 2).

6.1.1.2.2.3.4. Fourth step.

If V_1 is greater than or equal to V_2 , a standard known resistance (R_o) is inserted between the negative side of the high voltage bus and the electrical chassis. With R_o installed, the voltage (V_1') between the negative side of the high voltage bus and the electrical chassis is measured (see Figure 3).

The electrical isolation (R_i) is calculated according to the following formula:

$$R_i = R_o * (V_b / V_1' - V_b / V_1) \text{ or } R_i = R_o * V_b * (1 / V_1' - 1 / V_1)$$

Figure 3
Measurement of V_1'

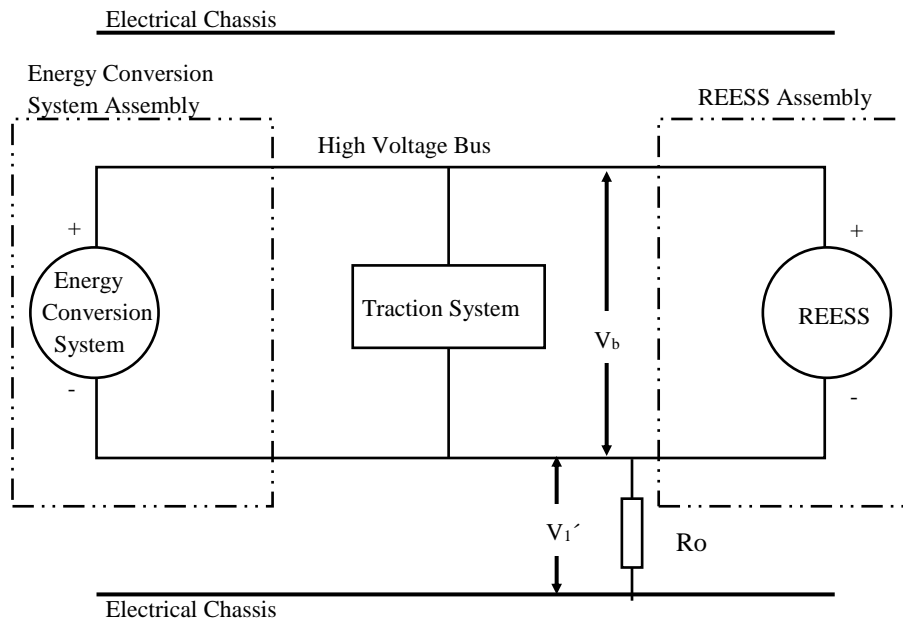

If V_2 is greater than V_1 , a standard known resistance (R_o) is inserted between the positive side of the high voltage bus and the electrical chassis. With R_o installed, the voltage (V_2') between the positive side of the high voltage bus and the electrical chassis is measured. (See Figure 4). The electrical isolation (R_i) is calculated according to the formula shown below. This electrical isolation value (in Ω) is divided by the nominal operating voltage of the high voltage bus (in V). The electrical isolation (R_i) is calculated according to the following formula:

$$R_i = R_o \cdot (V_b/V_2' - V_b/V_2) \text{ or } R_i = R_o \cdot V_b \cdot (1/V_2' - 1/V_2)$$

Figure 4
Measurement of V_2'

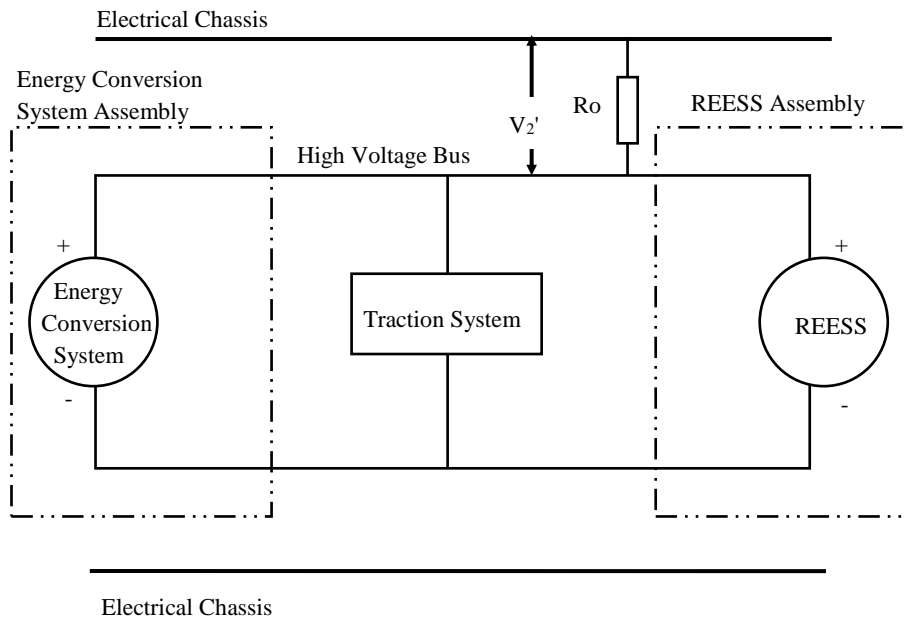

6.1.1.2.2.3.5. Fifth step.

The electrical isolation value R_i (in Ω) divided by the working voltage of the high voltage bus (in V) results in the isolation resistance (in Ω/V).

(Note 1: The standard known resistance R_o (in Ω) is the value of the minimum required isolation resistance (in Ω/V) multiplied by the working voltage of the vehicle plus/minus 20 per cent (in V). R_o is not required to be precisely this value since the equations are valid for any R_o ; however, a R_o value in this range should provide good resolution for the voltage measurements.)

6.1.2. Confirmation method for functions of on-board isolation resistance monitoring system.

The on-board isolation resistance monitoring system specified in paragraph 5.1.1.2.4.3. for fuel cell vehicles and that specified in paragraph 5.1.1.3.4 for protection against water effects shall be tested using the following procedure.

- (a) Determine the isolation resistance, R_i , of the electric power train with the electrical isolation monitoring system using the procedure outlined paragraph 6.1.1.
- (b) If the minimum isolation resistance value required in accordance with paragraphs 5.1.1.2.4.1. or 5.1.1.2.4.2. is $100 \Omega/V$, insert a resistor with resistance R_o between the positive terminal of the electric power train and the electrical chassis. The magnitude of the resistor, R_o , shall be such that:

$$1/(1/(95xV) - 1/R_i) \leq R_o < 1/(1/(100xV) - 1/R_i)$$

where V is the working voltage of the electric power train.

- (c) If the minimum isolation resistance value required in accordance with paragraphs 5.1.1.2.4.1. or 5.1.1.2.4.2. is $500 \Omega/V$, insert a resistor with resistance R_o between the positive terminal of the electric power train and the electrical chassis. The magnitude of the resistor, R_o , shall be such that:

$$1/(1/(475xV) - 1/R_i) \leq R_o < 1/(1/(500xV) - 1/R_i)$$

where V is the working voltage of the electric power train.

- 6.1.3. Protection against direct contact to live parts.

- 6.1.3.1. Access probes.

Access probes to verify the protection of persons against access to live parts are given in Table 1.

- 6.1.3.2. Test conditions.

The access probe is pushed against any openings of the enclosure with the force specified in Table 1. If it partly or fully penetrates, it is placed in every possible position, but in no case shall the stop face fully penetrate through the opening.

Internal electrical protection barriers are considered part of the enclosure.

A low-voltage supply (of not less than 40 V and not more than 50 V) in series with a suitable lamp is connected, if necessary, between the probe and live parts inside the electrical protection barrier or enclosure.

The signal-circuit method is also applied to the moving live parts of high voltage equipment.

Internal moving parts may be operated slowly, where this is possible.

- 6.1.3.3. Acceptance conditions.

The access probe shall not touch live parts.

If this requirement is verified by a signal circuit between the probe and live parts, the lamp shall not light.

In the case of the test for protection degree IPXXB, the jointed test finger may penetrate to its 80 mm length, but the stop face (diameter 50 mm x 20 mm) shall not pass through the opening. Starting from the straight position, both joints of the test finger are successively bent through an angle of up to 90 degree with respect to the axis of the adjoining section of the finger and are placed in every possible position.

In case of the tests for protection degree IPXXD, the access probe may penetrate to its full length, but the stop face shall not fully penetrate through the opening.

Table 1
Access probes for the tests for protection of persons against access to hazardous parts

First numeral	Addit. letter	Access probe (Dimensions in mm)	Test force
2	B	Jointed test finger 	10 N ± 10%
4, 5, 6	D	Test wire 1.0 mm diameter, 100 mm long 	1 N ± 10%

Figure 5
Jointed Test Finger



Material: metal, except where otherwise specified

Linear dimensions in mm.

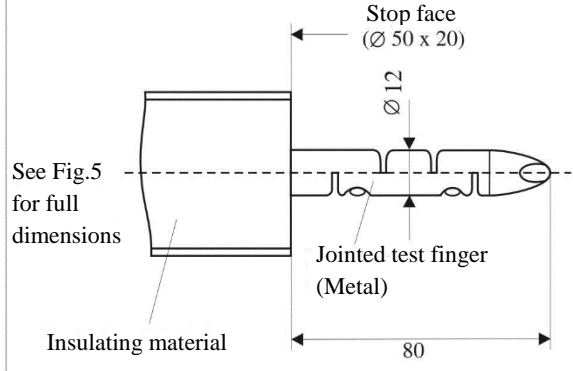
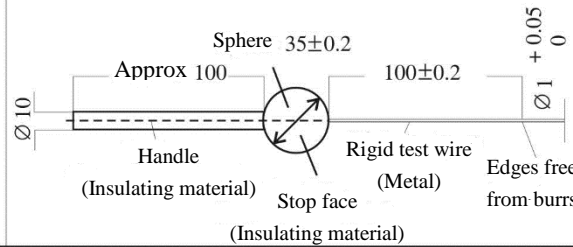
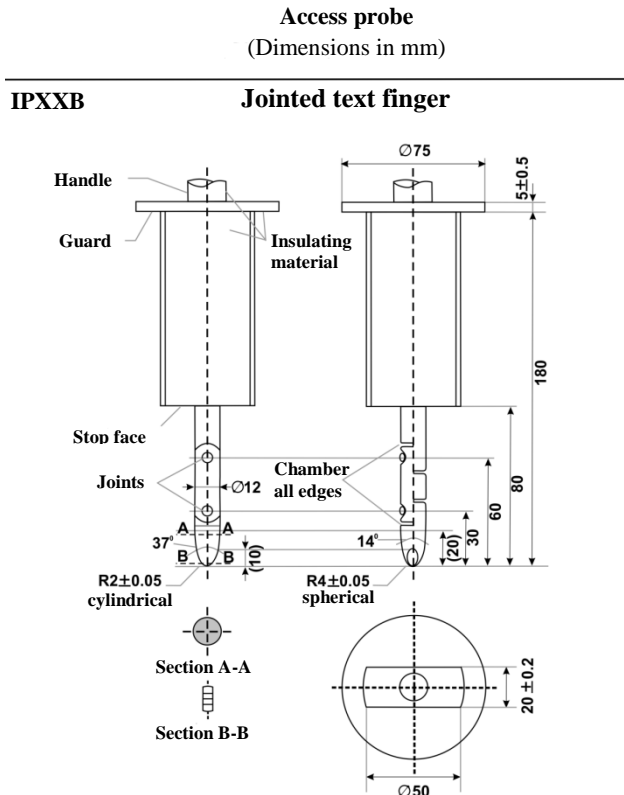
Tolerances on dimensions without specific tolerance:

- (a) on angles: 0/10 seconds;
- (b) on linear dimensions:
 - (i) up to 25 mm: 0/-0.05;
 - (ii) over 25 mm: ± 0.2 .

Both joints shall permit movement in the same plane and the same direction through an angle of 90° with a 0 to $+10^\circ$ tolerance.

6.1.4. Test method for measuring electric resistance:

- (a) Test method using a resistance tester.

The resistance tester is connected to the measuring points (typically, electrical chassis and electro conductive enclosure/electrical protection barrier) and the resistance is measured using a resistance tester that meets the specification that follows:

- (i) Resistance tester: Measurement current at least 0.2 A;
- (ii) Resolution: 0.01Ω or less;
- (iii) The resistance R shall be less than 0.1Ω .

- (b) Test method using DC power supply, voltmeter and ammeter.

Example of the test method using DC power supply, voltmeter and ammeter is shown below.

Figure 6

Example of test method using DC power supply

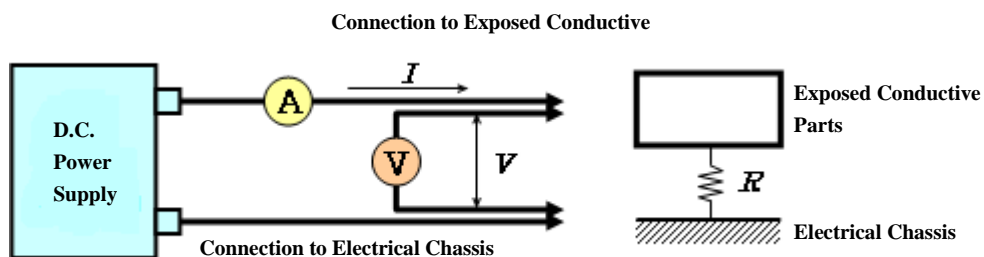

6.1.4.1. Test Procedure.

The DC power supply, voltmeter and ammeter are connected to the measuring points (Typically, electrical chassis and electro conductive enclosure/electrical protection barrier).

The voltage of the DC power supply is adjusted so that the current flow becomes at least 0.2 A.

The current "I" and the voltage "V" are measured.

The resistance "R" is calculated according to the following formula:

$$R = V / I$$

The resistance R shall be less than 0.1 Ω .

Note: If lead wires are used for voltage and current measurement, each lead wire shall be independently connected to the electrical protection barrier/enclosure/electrical chassis. Terminal can be common for voltage measurement and current measurement.

6.1.5. Test procedure for Protection against water effects.

6.1.5.1. Washing.

This test is intended to simulate the normal washing of vehicles, but not specific cleaning using high water pressure or underbody washing.

The areas of the vehicle regarding this test are border lines, i.e. a seal of two parts such as flaps, glass seals, outline of opening parts, outline of front grille and seals of lamps.

All border lines shall be exposed and followed in all directions with the water stream using a hose nozzle and conditions in accordance with IPX5 as specified in Annex 2.

6.1.5.2. Driving through standing water.

The vehicle shall be driven in a wade pool, with 10 cm water depth, over a distance of 500 m at a speed of 20 km/h, in a time of approximately 1.5 min. If the wade pool used is less than 500 m in length, then the vehicle shall be driven through it several times. The total time, including the periods outside the wade pool, shall be less than 10 min.

6.1.6. Test conditions and test procedure regarding post-crash.

6.1.6.1. Test conditions.

6.1.6.1.1. General.

The test conditions specified in paragraphs 6.1.6.1.2. to 6.1.6.1.4. are used.

6.1.6.1.2. Electric power train adjustment.

6.1.6.1.2.1. The SOC of the REESS shall be adjusted in accordance with the paragraph 6.2.1.2.

6.1.6.1.2.2. The electric power train shall be energized with or without the operation of the original electrical energy sources (e.g. engine-generator, REESS or electric energy conversion system), however:

6.1.6.1.2.2.1. It is permissible to perform the test with all or parts of the electric power train not being energized insofar as there is no negative influence on the test result. For parts of the electric power train not energized, the protection against electric shock shall be proved by either physical protection or isolation resistance and appropriate additional evidence.

6.1.6.1.2.2.2. If the electric power train is not energized and an automatic disconnect is provided, it is permissible to perform the test with the automatic disconnect being triggered. In this case it shall be demonstrated that the automatic disconnect would have operated during the impact test. This includes the automatic activation signal as well as the conductive separation considering the conditions as seen during the impact.

6.1.6.1.3. Contracting Parties may allow modifications to the fuel system so that an appropriate amount of fuel can be used to run the engine or the electric energy conversion system.

6.1.6.1.4. The vehicle conditions other than specified in paragraphs 6.1.6.1.1. to 6.1.6.1.3. are in accordance with the crash test protocols of the Contracting Parties.

6.1.6.2. Test procedures for the protection of the occupants from high voltage and electrolyte leakage.

This section describes test procedures to demonstrate compliance with the electrical safety requirements of paragraphs 5.2.2. and 5.5.1.

Before the vehicle impact test conducted, the high voltage bus voltage (V_b) (see Figure 7) is measured and recorded to confirm that it is within the operating voltage of the vehicle as specified by the vehicle manufacturer.

6.1.6.2.1. Test set-up and equipment.

If a high voltage disconnect function is used, measurements are taken from both sides of the device performing the disconnect function.

However, if the high voltage disconnect is integral to the REESS or the electric energy conversion system and the high-voltage bus of the REESS or the electric energy conversion system is protected according to protection degree IPXXB following the impact test, measurements may only be taken between the device performing the disconnect function and electrical loads.

The voltmeter used in this test measures DC values and have an internal resistance of at least 10 M Ω .

6.1.6.2.2. Voltage measurement.

After the impact test, determine the high voltage bus voltages (V_b , V_1 , V_2) (see Figure 7).

The voltage measurement is made no earlier than 10 s, but not later than 60 s after the impact.

This procedure is not applicable if the test is performed under the condition where the electric power train is not energized.

Figure 7
Measurement of V_b , V_1 , V_2

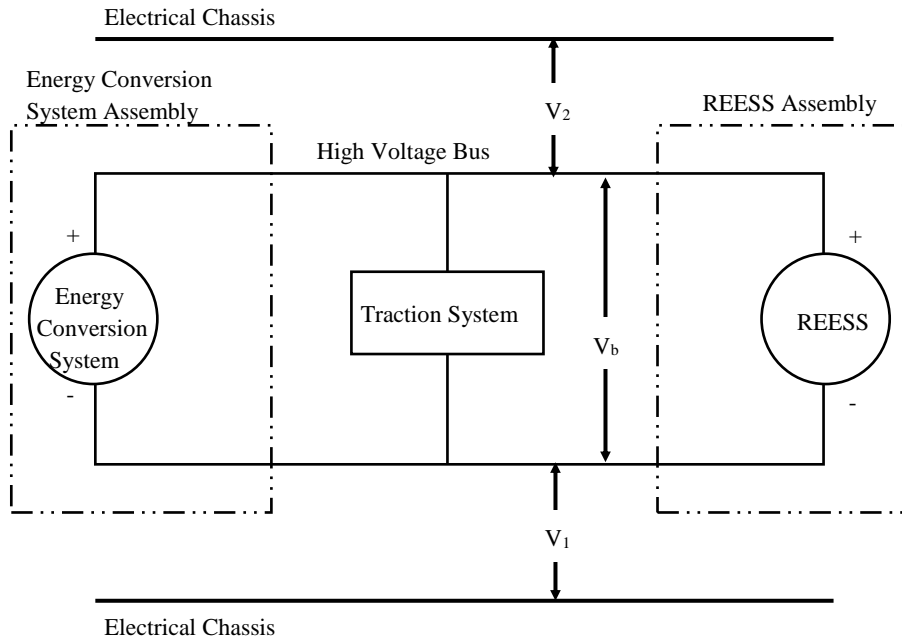

6.1.6.2.3. Assessment procedure for low electrical energy.

Prior to the impact a switch S_1 and a known discharge resistor R_e is connected in parallel to the relevant capacitance (Figure 8).

- (a) Not earlier than 10 s and not later than 60 s after the impact the switch S_1 shall be closed while the voltage V_b and the current I_e are measured and recorded. The product of the voltage V_b and the current I_e shall be integrated over the period of time, starting from the moment when the switch S_1 is closed (t_c) until the voltage V_b falls to zero (t_h). The

$$TE = \int_{t_c}^{t_h} V_b \times I_e dt$$

resulting integration equals the total energy (TE) in J.

- (b) When V_b is measured at a point in time between 10 s and 60 s after the impact and the capacitance of the X-capacitors (C_x) is specified by the manufacturer, total energy (TE) shall be calculated according to the following formula:

$$TE = 0.5 \times C_x \times V_b^2$$

- (c) When V_1 and V_2 (see Figure 8) are measured at a point in time between 10 s and 60 s after the impact and the capacitances of the Y-capacitors (C_{y1} , C_{y2}) are specified by the manufacturer, total energy (TE_{y1} , TE_{y2}) shall be calculated according to the following formulas:

$$TE_{y1} = 0.5 \times C_{y1} \times V_1^2$$

$$TE_{y2} = 0.5 \times C_{y2} \times V_2^2$$

This procedure is not applicable if the test is performed under the condition where the electric power train is not energized.

Figure 8

Example of measurement of high voltage bus energy stored in X-capacitors

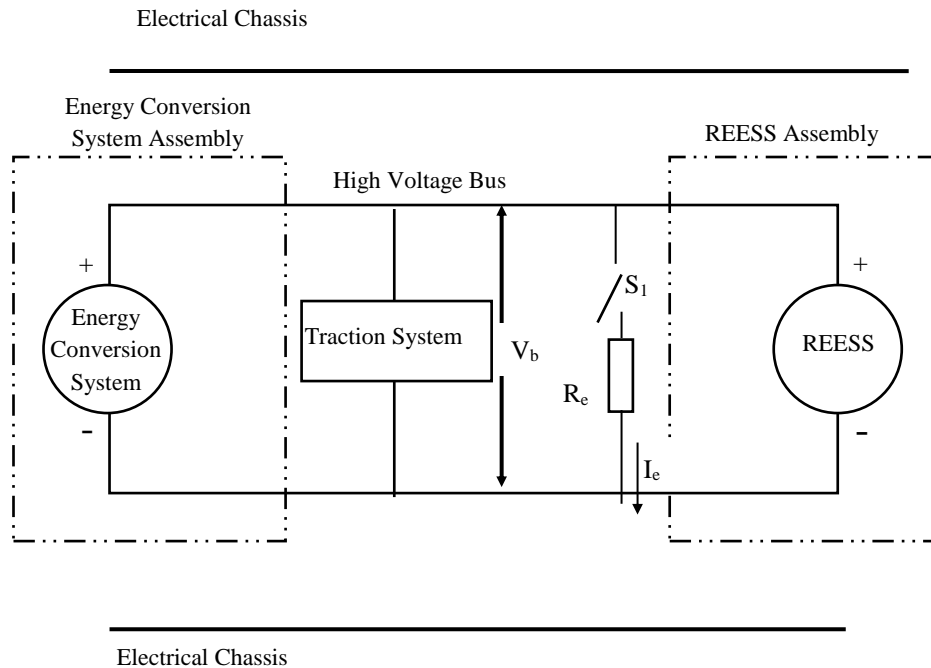

6.1.6.2.4. Physical protection.

Following the vehicle crash test, any parts surrounding the high voltage components shall be opened, disassembled or removed to the extent possible without the use of tools. All remaining surrounding parts are considered as the physical protection.

The Jointed Test Finger described in paragraph 6.1.3. is inserted into any gaps or openings of the physical protection with a test force of $10 \text{ N} \pm 10$ per cent for electrical safety assessment. If partial or full penetration into the physical protection by the Jointed Test Finger occurs, the Jointed Test Finger shall be placed in every position as specified below.

Starting from the straight position, both joints of the test finger are rotated progressively through an angle of up to 90° with respect to the axis of the adjoining section of the finger and are placed in every possible position.

Internal electrical protection barriers are considered part of the enclosure.

If appropriate, a low-voltage supply (of not less than 40 V and not more than 50 V) in series with a suitable lamp is connected between the Jointed Test Finger and high voltage live parts inside the electrical protection barrier or enclosure.

The requirements of paragraph 5.2.2.3. are met if the Jointed Test Finger described in paragraph 6.1.3. is unable to contact high voltage live parts.

If necessary a mirror or a fiberscope may be used in order to inspect whether the Jointed Test Finger touches the high voltage buses.

If this requirement is verified by a signal circuit between the Jointed Test Finger and high voltage live parts, the lamp shall not light.

6.1.6.2.4.1. Voltage between exposed conductive barriers.

The voltage difference between exposed conductive parts of electrical protection barriers and the electrical chassis shall be measured. The voltage difference between two simultaneously reachable exposed conductive parts of electrical protection barriers/enclosures shall be measured or calculated using other measured voltages.

6.1.6.2.5. Isolation resistance.

The measurement shall be conducted according to paragraph 6.1.1. with the following precaution.

All measurements for calculating voltage(s) and electrical isolation are made after a minimum of 10 s after the impact.

6.1.6.2.6. Electrolyte leakage.

An appropriate coating, if necessary, may be applied to the physical protection (casing) in order to confirm if there is any electrolyte leakage from the REESS resulting from the test. Unless the manufacturer provides a means to differentiate between the leakage of different liquids, all liquid leakage shall be considered as the electrolyte.

6.2. Test procedures for REESS.

6.2.1. General procedures.

6.2.1.1. Procedure for conducting a standard cycle.

Procedure for conducting a standard cycle for a complete REESS, REESS subsystem(s), or complete vehicle.

A standard cycle shall start with a standard discharge and is followed by a standard charge. The standard cycle shall be conducted at an ambient temperature of 20 ± 10 °C.

Standard discharge:

Discharge rate: The discharge procedure including termination criteria shall be defined by the manufacturer. If not specified, then it shall be a discharge with 1C current for a complete REESS and REESS subsystems.

Discharge limit (end voltage): Specified by the manufacturer.

For a complete vehicle, discharge procedure using a dynamometer shall be defined by the manufacturer. Discharge termination will be according to vehicle controls.

Rest period after discharge: minimum 15 min

Standard charge:

The charge procedure shall be defined by the manufacturer. If not specified, then it shall be a charge with $C/3$ current. Charging is continued until normally terminated. Charge termination shall be according to paragraph 6.2.1.2.2. for REESS or REESS subsystem.

For a complete vehicle that can be charged by an external source, charge procedure using an external electric power supply shall be defined by the manufacturer. For a complete vehicle that can be charged by on-board energy sources, a charge procedure using a dynamometer shall be defined by the manufacturer. Charge termination will be according to vehicle controls.

- 6.2.1.2. Procedures for SOC adjustment.
- 6.2.1.2.1. The adjustment of SOC shall be conducted at an ambient temperature of 20 ± 10 °C for vehicle-based tests and 22 ± 5 °C for component-based tests.
- 6.2.1.2.2. The SOC of the Tested-Device shall be adjusted according to one of the following procedures as applicable. Where different charging procedures are possible, the REESS shall be charged using the procedure which yields the highest SOC:
 - (a) For a vehicle with a REESS designed to be externally charged, the REESS shall be charged to the highest SOC in accordance with the procedure specified by the manufacturer for normal operation until the charging process is normally terminated.
 - (b) For a vehicle with a REESS designed to be charged only by an energy source on the vehicle, the REESS shall be charged to the highest SOC which is achievable with normal operation of the vehicle. The manufacturer shall advise on the vehicle operation mode to achieve this SOC.
 - (c) In case that the REESS or REESS sub-system is used as the Tested-Device, the Tested-Device shall be charged to the highest SOC in accordance with the procedure specified by the manufacturer for normal use operation until the charging process is normally terminated. Procedures specified by the manufacturer for manufacturing, service or maintenance may be considered as appropriate if they achieve an equivalent SOC as for that under normal operating conditions. In case the Tested-Device does not control SOC by itself, the SOC shall be charged to not less than 95 per cent of the maximum normal operating SOC defined by the manufacturer for the specific configuration of the Tested-Device.
- 6.2.1.2.3. When the vehicle or REESS subsystem is tested, the SOC shall be no less than 95 per cent of the SOC according to paragraphs 6.2.1.2.1. and 6.2.1.2.2. for REESS designed to be externally charged and shall be no less than 90 per cent of SOC according to paragraphs 6.2.1.2.1. and 6.2.1.2.2. for REESS designed to be charged only by an energy source on the vehicle. The SOC will be confirmed by a method provided by the manufacturer.
- 6.2.2. Vibration test.
- 6.2.2.1. Purpose.

The purpose of this test is to verify the safety performance of the REESS under a vibration environment which the REESS will likely experience during the normal operation of the vehicle.
- 6.2.2.2. Installations.
- 6.2.2.2.1. This test shall be conducted either with the complete REESS or with REESS subsystem(s). If the manufacturer chooses to test with REESS subsystem(s), the manufacturer shall demonstrate that the test result can reasonably

represent the performance of the complete REESS with respect to its safety performance under the same conditions. If the electronic management control unit for the REESS is not integrated in the casing enclosing the cells, then the electronic management unit may be omitted from installation on the Tested-Device if so requested by the manufacturer.

6.2.2.2.2. The Tested-Device shall be firmly secured to the platform of the vibration machine in such a manner as to ensure that the vibrations are directly transmitted to the Tested-Device.

The Test-Device should be mounted with its original mounting points and holders as mounted in the vehicle. The holders should be firmly secured to the platform of the vibration machine in such a manner as to ensure that the vibrations are directly transmitted to the holders of the Tested-Device.

6.2.2.3. Procedures.

6.2.2.3.1. General test conditions.

The following conditions shall apply to the Tested-Device:

- (a) The test shall be conducted at an ambient temperature of 22 ± 5 °C;
- (b) At the beginning of the test, the SOC shall be adjusted in accordance with the paragraph 6.2.1.2.;
- (c) At the beginning of the test, all protection devices which affect the function(s) of the Tested-Device that are relevant to the outcome of the test shall be operational.

6.2.2.3.2. Test procedures.

The Tested-Device shall be subjected to a vibration having a sinusoidal waveform with a logarithmic sweep between 7 Hz and 50 Hz and back to 7 Hz traversed in 15 minutes. This cycle shall be repeated 12 times for a total of 3 hours in the vertical direction of the mounting orientation of the REESS as specified by the manufacturer.

The correlation between frequency and acceleration shall be as shown in Table 2:

Table 2
Frequency and acceleration

<i>Frequency</i> (Hz)	<i>Acceleration</i> (m/s^2)
7 - 18	10
18 - 30	gradually reduced from 10 to 2
30 - 50	2

At the request of the manufacturer, a higher acceleration level as well as a higher maximum frequency may be used.

At the choice of the manufacturer, a vibration test profile determined by the vehicle manufacturer verified for the vehicle application may be used as a substitute for the frequency - acceleration correlation of Table 2. The REESS

certified according to this condition shall be limited to the installation for a specific vehicle type.

After the vibration profile, a standard cycle as described in paragraph 6.2.1.1. shall be conducted, if not inhibited by the Tested-Device.

The test shall end with an observation period of 1 hour at the ambient temperature conditions of the test environment.

6.2.3. Thermal shock and cycling test.

6.2.3.1. Purpose.

The purpose of this test is to verify the resistance of the REESS to sudden changes in temperature. The REESS shall undergo a specified number of temperature cycles, which start at ambient temperature followed by high and low temperature cycling. It simulates a rapid environmental temperature change which a REESS would likely experience during its life.

6.2.3.2. Installations.

This test shall be conducted either with the complete REESS or with REESS subsystem(s). If the manufacturer chooses to test with REESS subsystem(s), the manufacturer shall demonstrate that the test result can reasonably represent the performance of the complete REESS with respect to its safety performance under the same conditions. If the electronic management unit for the REESS is not integrated in the casing enclosing the cells, then the electronic management unit may be omitted from installation on the Tested-Device if so requested by the manufacturer.

6.2.3.3. Procedures.

6.2.3.3.1. General test conditions.

The following conditions shall apply to the Tested-Device at the start of the test:

- (a) At the beginning of the test, the SOC shall be adjusted in accordance with the paragraph 6.2.1.2.;
- (b) All protection devices, which would affect the function of the Tested-Device and which are relevant to the outcome of the test shall be operational.

6.2.3.3.2. Test procedure.

The Tested-Device shall be stored for at least 6 hours at a test temperature equal to 60 ± 2 °C or higher if requested by the manufacturer, followed by storage for at least 6 hours at a test temperature equal to -40 ± 2 °C or lower if requested by the manufacturer. The maximum time interval between test temperature extremes shall be 30 minutes. This procedure shall be repeated until a minimum of 5 total cycles are completed, after which the Tested-Device shall be stored for 24 hours at an ambient temperature of 22 ± 5 °C.

After the storage for 24 hours, a standard cycle as described in paragraph 6.2.1.1. shall be conducted, if not inhibited by the Tested-Device.

The test shall end with an observation period of 1 hour at the ambient temperature conditions of the test environment.

- 6.2.4. Fire resistance test.
- 6.2.4.1. Purpose.
- The purpose of this test is to verify the resistance of the REESS, against exposure to fire from outside of the vehicle due to e.g. a fuel spill from a vehicle (either the vehicle itself or a nearby vehicle). This situation should leave the driver and passengers with enough time to evacuate.
- 6.2.4.2. Installations.
- 6.2.4.2.1 This test shall be conducted either with the complete REESS or with REESS subsystem(s). If the manufacturer chooses to test with REESS subsystem(s), the manufacturer shall demonstrate that the test result can reasonably represent the performance of the complete REESS with respect to its safety performance under the same conditions. If the electronic management unit for the REESS is not integrated in the casing enclosing the cells, then the electronic management unit may be omitted from installation on the Tested-Device if so requested by the manufacturer. Where the relevant REESS subsystems are distributed throughout the vehicle, the test may be conducted on each relevant REESS subsystem.
- 6.2.4.3. Procedures.
- 6.2.4.3.1. General test conditions.
- The following requirements and conditions shall apply to the test:
- (a) The test shall be conducted at a temperature of at least 0 °C;
 - (b) At the beginning of the test, the SOC shall be adjusted according to paragraph 6.2.1.2.;
 - (c) At the beginning of the test, all protection devices which affect the function of the Tested-Device and are relevant for the outcome of the test shall be operational.
- 6.2.4.3.2. Test procedure.
- A vehicle based test or a component based test shall be performed at the discretion of the manufacturer.
- 6.2.4.3.2.1. Vehicle based test (according to test procedure described in paragraph 6.2.4.3.3.).
- The Tested-Device shall be mounted in a testing fixture simulating actual mounting conditions as far as possible; no combustible material should be used for this with the exception of material that is part of the REESS. The method whereby the Tested-Device is fixed in the fixture shall correspond to the relevant specifications for its installation in a vehicle. In the case of a REESS designed for a specific vehicle use, vehicle parts which affect the course of the fire in any way shall be taken into consideration.
- 6.2.4.3.2.2. Component based test (according to test procedure described in paragraph 6.2.4.3.3. (Gasoline pool fire) or paragraph 6.2.4.3.4. (LPG burner)).
- In case of component based test, the manufacturer may choose either Gasoline pool fire test or LPG burner test.

- 6.2.4.3.3. Gasoline pool fire test set up for both vehicle-based and component-based test.

The Tested-Device shall be placed on a grating table positioned above the fire source, in an orientation according to the manufacturer's design intent.

The grating table shall be constructed by steel rods, diameter 6-10 mm, with 4-6 cm in between. If needed the steel rods could be supported by flat steel parts.

The flame to which the Tested-Device is exposed shall be obtained by burning commercial fuel for positive-ignition engines (hereafter called "fuel") in a pan. The quantity of fuel shall be sufficient to permit the flame, under free-burning conditions, to burn for the whole test procedure.

The fire shall cover the whole area of the pan during whole fire exposure. The pan dimensions shall be chosen so as to ensure that the sides of the Tested-Device are exposed to the flame. The pan shall therefore exceed the horizontal projection of the Tested-Device by at least 20 cm, but not more than 50 cm. The sidewalls of the pan shall not project more than 8 cm above the level of the fuel at the start of the test.

- 6.2.4.3.3.1. The pan filled with fuel shall be placed under the Tested-Device in such a way that the distance between the level of the fuel in the pan and the bottom of the Tested-Device corresponds to the design height of the Tested-Device above the road surface at the unladen mass if paragraph 6.2.4.3.2.1. is applied or approximately 50 cm if paragraph 6.2.4.3.2.2. is applied. Either the pan, or the testing fixture, or both, shall be freely movable.

- 6.2.4.3.3.2. During phase C of the test, the pan shall be covered by a screen. The screen shall be placed 3 cm +/- 1 cm above the fuel level measured prior to the ignition of the fuel. The screen shall be made of a refractory material, as prescribed in Figure 13. There shall be no gap between the bricks and they shall be supported over the fuel pan in such a manner that the holes in the bricks are not obstructed. The length and width of the frame shall be 2 cm to 4 cm smaller than the interior dimensions of the pan so that a gap of 1 cm to 2 cm exists between the frame and the wall of the pan to allow ventilation. Before the test the screen shall be at least at the ambient temperature. The firebricks may be wetted in order to guarantee repeatable test conditions.

- 6.2.4.3.3.3. If the tests are carried out in the open air, sufficient wind protection shall be provided and the wind velocity at pan level shall not exceed 2.5 km/h.

- 6.2.4.3.3.4. The test shall comprise three phases B-D, if the fuel is at a temperature of at least 20 °C. Otherwise, the test shall comprise four phases A-D.

- 6.2.4.3.3.4.1. Phase A: Pre-heating (Figure 9).

The fuel in the pan shall be ignited at a distance of at least 3 m from the Tested-Device. After 60 seconds pre-heating, the pan shall be placed under the Tested-Device. If the size of the pan is too large to be moved without risking liquid spills etc. then the Tested-Device and test rig can be moved over the pan instead.

Figure 9
Phase A: Pre-heating

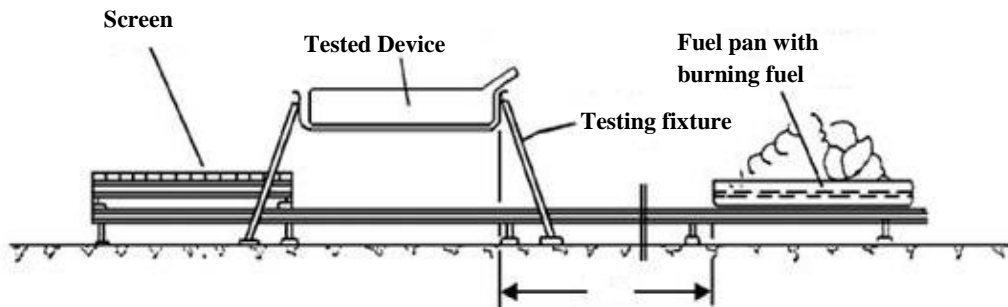

6.2.4.3.3.4.2. Phase B: Direct exposure to flame (Figure 10)

The Tested-Device shall be exposed to the flame from the freely burning fuel for 70 seconds.

Figure 10
Phase B: Direct exposure to flame

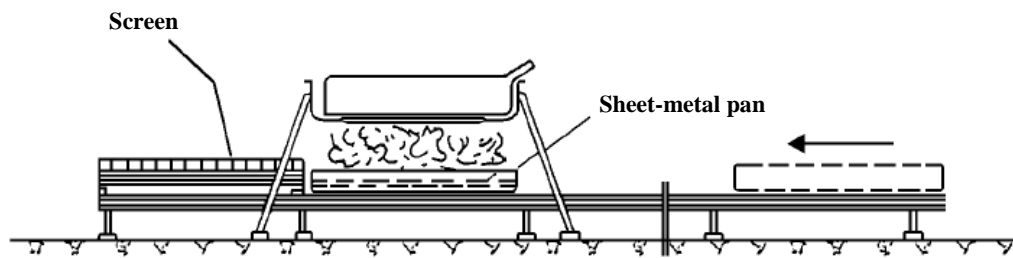

6.2.4.3.3.4.3. Phase C: Indirect exposure to flame (Figure 11).

As soon as phase B has been completed, the screen shall be placed between the burning pan and the Tested-Device. The Tested-Device shall be exposed to this reduced flame for a further 60 seconds.

As a compliance alternative to conducting Phase C of the test, Phase B may, at the choice of the manufacturer, be continued for an additional 60 seconds.

Figure 11
Phase C: Indirect exposure to flame

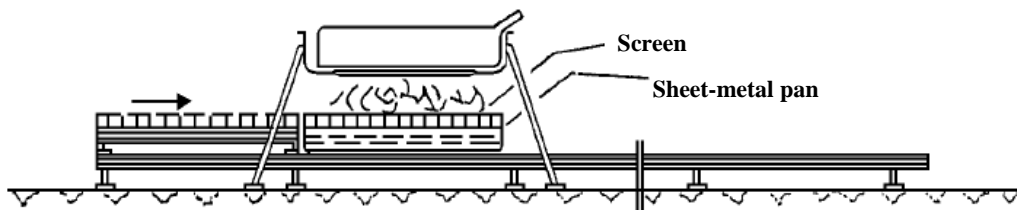

6.2.4.3.3.4.4. Phase D: End of test (Figure 12).

The burning pan covered with the screen shall be moved back to the position described in phase A. No extinguishing of the Tested-Device shall be done. After removal of the pan, the Tested-Device shall be observed until such time as the surface temperature of the Tested-Device has decreased to ambient temperature or has been decreasing for a minimum of 3 hours.

Figure 12

Phase D: End of test

Figure 13

Dimension of Firebricks

Fire resistance	(Seger-Kegel) SK 30
Al ₂ O ₃ content	30 - 33 per cent
Open porosity (Po)	20 - 22 per cent vol.
Density	1,900 - 2,000 kg/m ³
Effective holed area	44.18 per cent

6.2.4.3.4. LPG burner fire test set up for component based test.

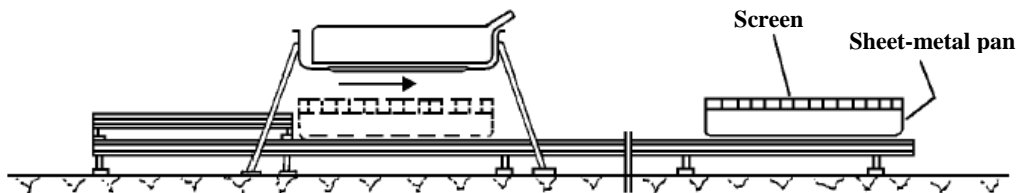
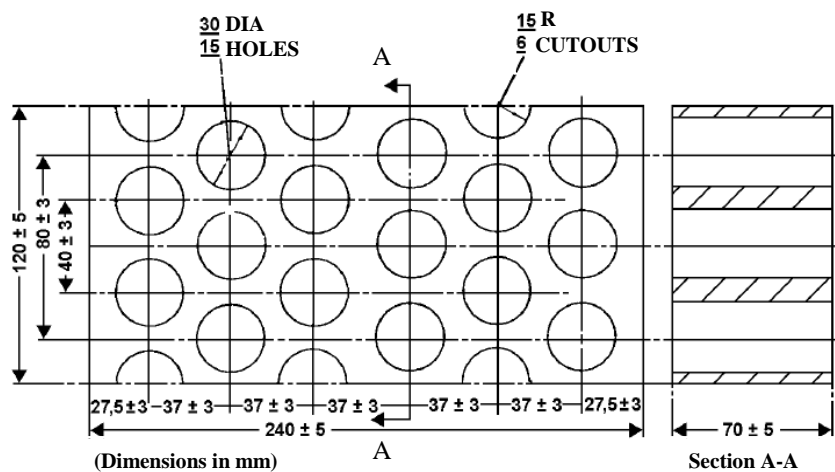
6.2.4.3.4.1. The Tested-Device shall be placed on a test equipment, in the position that the manufacturer's design intends.

6.2.4.3.4.2. LPG burner shall be used to produce flame to which the Tested-Device is exposed. The height of the flame shall be about 60 cm or more, without the Tested-Device.

- 6.2.4.3.4.3. The flame temperature shall be measured continuously by temperature sensors. An average temperature shall be calculated, at least every second for the duration of the whole fire exposure, as the arithmetic average of temperatures measured by all temperature sensors fulfilling the location requirements described in paragraph 6.2.4.3.4.4.
- 6.2.4.3.4.4. All temperature sensors shall be installed at a height of 5 ± 1 cm below the lowest point of the Tested-Device's external surface when oriented as described in paragraph 6.2.4.3.4.1. At least one temperature sensor shall be located at the centre of Tested-Device, and at least four temperature sensors shall be located within 10 cm from the edge of the Tested-Device towards its centre with nearly equal distance between the sensors.
- 6.2.4.3.4.5. The bottom of Tested-Device shall be exposed to the even flame directly and entirely by fuel combustion. LPG burner flame shall exceed the horizontal projection of the Tested-Device by at least 20 cm.
- 6.2.4.3.4.6. The Tested-Device shall be exposed to flame for 2 minutes after the averaged temperature reaches $800 \text{ }^{\circ}\text{C}$ within 30 seconds. The averaged temperature shall be maintained at $800\text{-}1,100 \text{ }^{\circ}\text{C}$ for 2 minutes.
- 6.2.4.3.4.7. After direct exposure to flame the Tested-Device shall be observed until such time as the surface temperature of the Tested-Device has decreased to ambient temperature or has been decreasing for a minimum of 3 hours.
- 6.2.5. External short circuit protection.
- 6.2.5.1. Purpose.
- The purpose of this test is to verify the performance of the short circuit protection to prevent the REESS from any further related severe events caused by short circuit current.
- 6.2.5.2. Installations.
- This test shall be conducted either with a complete vehicle or with the complete REESS or with the REESS subsystem(s). If the manufacturer chooses to test with REESS subsystem(s), the Tested-Device shall be able to deliver the nominal voltage of the complete REESS and the manufacturer shall demonstrate that the test result can reasonably represent the performance of the complete REESS with respect to its safety performance under the same conditions. If the electronic management unit for the REESS is not integrated in the casing enclosing the cells, then the electronic management unit may be omitted from installation on the Tested-Device at the request of the manufacturer.
- For a test with a complete vehicle, the manufacturer may provide information to connect a breakout harness to a location just outside the REESS that would permit applying a short circuit to the REESS.
- 6.2.5.3. Procedures.
- 6.2.5.3.1. General test conditions.
- The following condition shall apply to the test:
- (a) The test shall be conducted at an ambient temperature of $20 \pm 10 \text{ }^{\circ}\text{C}$ or at a higher temperature if requested by the manufacturer;
- (b) At the beginning of the test, the SOC shall be adjusted according to paragraph 6.2.1.2.;

- (c) For testing with a complete REESS or REESS subsystem(s), at the beginning of the test, all protection devices which would affect the function of the Tested-Device and which are relevant to the outcome of the test shall be operational;
- (d) For testing with a complete vehicle, a breakout harness is connected to the manufacturer specified location and vehicle protections systems relevant to the outcome of the test shall be operational.

6.2.5.3.2. Short circuit.

At the start of the test all, relevant main contactors for charging and discharging shall be closed to represent the active driving possible mode as well as the mode to enable external charging. If this cannot be completed in a single test, then two or more tests shall be conducted.

For testing with a complete REESS or REESS subsystem(s), the positive and negative terminals of the Tested-Device shall be connected to each other to produce a short circuit. The connection used for creating the short circuit (including the cabling) shall have a resistance not exceeding 5 mΩ.

For testing with a complete vehicle, the short circuit is applied through the breakout harness. The connection used for creating the short circuit (including the cabling) shall have a resistance not exceeding 5 mΩ.

The short circuit condition shall be continued until the protection function operation of the REESS terminates the short circuit current, or for at least 1 hr after the temperature measured on the casing of the Tested-Device or the REESS has stabilized, such that the temperature gradient varies by less than 4 °C through 2 hours.

6.2.5.3.3. Standard Cycle and observation period.

Directly after the termination of the short circuit a standard cycle as described in paragraph 6.2.1.1. shall be conducted, if not inhibited by the Tested-Device.

The test shall end with an observation period of 1 h at the ambient temperature conditions of the test environment.

6.2.6. Overcharge protection test.

6.2.6.1. Purpose.

The purpose of this test is to verify the performance of the overcharge protection to prevent the REESS from any further related severe events caused by a too high SOC.

6.2.6.2. Installations.

This test shall be conducted, under standard operating conditions, either with a complete vehicle or with the complete REESS. Ancillary systems that do not influence the test results may be omitted from the Tested-Device.

The test may be performed with a modified Tested-Device provided these modifications shall not influence the test results.

6.2.6.3. Procedures.

6.2.6.3.1. General test conditions.

The following requirements and conditions shall apply to the test:

- (a) The test shall be conducted at an ambient temperature of 20 ± 10 °C or at a higher temperature if requested by the manufacturer;
- (b) The SOC of REESS shall be adjusted around the middle of normal operating range by normal operation recommended by the manufacturer such as driving the vehicle or using an external charger. The accurate adjustment is not required as long as the normal operation of the REESS is enabled;
- (c) For vehicle-based test of vehicles with on-board energy conversion systems (e.g. internal combustion engine, fuel cell, etc.), fill the fuel to allow the operation of such energy conversion systems;
- (d) At the beginning of the test, all protection devices which would affect the function of the Tested-Device and which are relevant to the outcome of the test shall be operational. All relevant main contactors for charging shall be closed.

6.2.6.3.2. Charging.

The procedure for charging the REESS for vehicle-based test shall be in accordance with paragraphs 6.2.6.3.2.1. and 6.2.6.3.2.2. and shall be selected as appropriate for the relevant mode of vehicle operation and the functionality of the protection system. Alternatively, the procedure for charging the REESS for vehicle-based test shall be in accordance with paragraph 6.2.6.3.2.3. For component-based test, the charging procedure shall be in accordance with paragraph 6.2.6.3.2.4.

6.2.6.3.2.1. Charge by vehicle operation.

This procedure is applicable to the vehicle-based tests in active driving possible mode:

- (a) For vehicles that can be charged by on-board energy sources (e.g. energy recuperation, on-board energy conversion systems), the vehicle shall be driven on a chassis dynamometer. The vehicle operation on a chassis dynamometer (e.g. simulation of continuous down-hill driving) that will deliver as high charging current as reasonably achievable shall be determined, if necessary, through consultation with the manufacturer.
- (b) The REESS shall be charged by the vehicle operation on a chassis dynamometer in accordance with paragraph 6.2.6.3.2.1.(a). The vehicle operation on the chassis dynamometer shall be terminated when the vehicle's overcharge protection controls terminates the REESS charge current or the temperature of the REESS is stabilized such that the temperature varies by a gradient of less than 2 °C through 1 hour. Where an automatic interrupt function vehicle's overcharge protection control fails to operate, or if there is no such control function, the charging shall be continued until the REESS temperature reaches 10 °C above its maximum operating temperature specified by the manufacturer.
- (c) Immediately after the termination of charging, one standard cycle as described in paragraph 6.2.1.1. shall be conducted, if it is not prohibited by the vehicle, with vehicle operation on a chassis dynamometer.

6.2.6.3.2.2. Charge by external electricity supply (vehicle-based test).

This procedure is applicable to vehicle-based test for externally chargeable vehicles:

- (a) The vehicle inlet for normal use, if it exists, shall be used for connecting the external electricity supply equipment. The charge control communication of the external electricity supply equipment shall be altered or disabled to allow the charging specified in paragraph 6.2.6.3.2.2.(b) below;
- (b) The REESS shall be charged by the external electricity supply equipment with the maximum charge current specified by the manufacturer. The charging shall be terminated when the vehicle's overcharge protection control terminates the REESS charge current. Where vehicle's overcharge protection control fails to operate, or if there is no such control, the charging shall be continued until the REESS temperature reaches 10 °C above its maximum operating temperature specified by the manufacturer. In the case where charge current is not terminated and where the REESS temperature remains less than 10 °C above the maximum operating temperature, vehicle operation shall be terminated 12 hours after the start of charging by external electricity supply equipment;
- (c) Immediately after the termination of charging, one standard cycle as described in paragraph 6.2.1.1. shall be conducted, if it is not prohibited by the vehicle, with vehicle operation on a chassis dynamometer for discharging and with external electricity supply equipment for charging.

6.2.6.3.2.3. Charge by connecting breakout harness (vehicle-based test).

This procedure is applicable to vehicle-based tests for both externally chargeable vehicles and vehicles that can be charged only by on-board energy sources and for which the manufacturer provides information to connect a breakout harness to a location just outside the REESS that permits charging of the REESS:

- (a) The breakout harness is connected to the vehicle as specified by the manufacturer. The trip current/voltage setting of the external charge-discharge equipment shall be at least 10 per cent higher than the current/voltage limit of the Tested-Device. The external electricity supply equipment is connected to the breakout harness. The REESS shall be charged by the external electricity power supply with the maximum charge current specified by the manufacturer;
- (b) The charging shall be terminated when the vehicle's overcharge protection control terminates the REESS charge current. Where vehicle's overcharge protection control fails to operate, or if there is no such control, the charging shall be continued until the REESS temperature is 10 °C above its maximum operating temperature specified by the manufacturer. In the case where charge current is not terminated and where the REESS temperature remains less than 10 °C above the maximum operating temperature, vehicle operation shall be terminated 12 hours after the start of charging by external electricity supply equipment;

- (c) Immediately after the termination of charging, one standard cycle as described in paragraph 6.2.1.1. (for a complete vehicle) shall be conducted, if it is not prohibited by the vehicle.

6.2.6.3.2.4. Charge by external electricity supply (component-based test).

This procedure is applicable to component-based test:

- (a) The external charge/discharge equipment shall be connected to the main terminals of the REESS. The charge control limits of the test equipment shall be disabled;
- (b) The REESS shall be charged by the external charge/discharge equipment with the maximum charge current specified by the manufacturer. The charging shall be terminated when the REESS overcharge protection control terminates the REESS charge current. Where overcharge protection control of the REESS fails to operate, or if there is no such control, the charging shall be continued until the REESS temperature reaches 10 °C above its maximum operating temperature specified by the manufacturer. In the case where charge current is not terminated and where the REESS temperature remains less than 10 °C above the maximum operating temperature, vehicle operation shall be terminated 12 hours after the start of charging by external electricity supply equipment;
- (c) Immediately after the termination of charging, one standard cycle as described in paragraph 6.2.1.1. shall be conducted, if it is not prohibited by the REESS, with external charge-discharge equipment.

6.2.6.4. The test shall end with an observation period of 1 hour at the ambient temperature conditions of the test environment.

6.2.7. Over-discharge protection test.

6.2.7.1. Purpose.

The purpose of this test is to verify the performance of the over-discharge protection to prevent the REESS from any severe events caused by a too low SOC.

6.2.7.2. Installations.

This test shall be conducted, under standard operating conditions, either with a complete vehicle or with the complete REESS. Ancillary systems that do not influence the test results may be omitted from the Tested-Device.

The test may be performed with a modified Tested-Device provided these modifications shall not influence the test results.

6.2.7.3. Procedures.

6.2.7.3.1. General test conditions.

The following requirements and condition shall apply to the test:

- (a) The test shall be conducted at an ambient temperature of 20 ± 10 °C or at a higher temperature if requested by the manufacturer;
- (b) The SOC of REESS shall be adjusted at the low level, but within normal operating range, by normal operation recommended by the manufacturer, such as driving the vehicle or using an external charger.

Accurate adjustment is not required as long as the normal operation of the REESS is enabled;

- (c) For vehicle-based test of vehicles with on-board energy conversion systems (e.g. internal combustion engine, fuel cell, etc.), adjust the fuel level to nearly empty but enough so that the vehicle can enter into active driving possible mode;
- (d) At the beginning of the test, all protection devices which would affect the function of the Tested-Device and which are relevant for the outcome of the test shall be operational.

6.2.7.3.2. Discharging.

The procedure for discharging the REESS for vehicle-based test shall be in accordance with paragraphs 6.2.7.3.2.1. and 6.2.7.3.2.2. Alternatively, the procedure for discharging the REESS for vehicle-based test shall be in accordance with paragraph 6.2.7.3.2.3. For component-based test, the discharging procedure shall be in accordance with paragraph 6.2.7.3.2.4.

6.2.7.3.2.1. Discharge by vehicle driving operation.

This procedure is applicable to the vehicle-based tests in active driving possible mode:

- (a) The vehicle shall be driven on a chassis dynamometer. The vehicle operation on a chassis dynamometer (e.g. simulation of continuous driving at steady speed) that will deliver as constant discharging power as reasonably achievable shall be determined, if necessary, through consultation with the manufacturer;
- (b) The REESS shall be discharged by the vehicle operation on a chassis dynamometer in accordance with paragraph 6.2.7.3.2.1.(a). The vehicle operation on the chassis dynamometer shall be terminated when the vehicle's over-discharge protection control terminates REESS discharge current or the temperature of the REESS is stabilized such that the temperature varies by a gradient of less than 4°C through 2 hours. Where an over-discharge protection control fails to operate, or if there is no such control, then the discharging shall be continued until the REESS is discharged to 25 per cent of its nominal voltage level;
- (c) Immediately after the termination of discharging, one standard charge followed by a standard discharge as described in paragraph 6.2.1.1. shall be conducted if it is not prohibited by the vehicle.

6.2.7.3.2.2. Discharge by auxiliary electrical equipment (vehicle-based test).

This procedure is applicable to the vehicle-based tests in stationary condition:

- (a) The vehicle shall be switched in to a stationary operation mode that allow consumption of electrical energy from REESS by auxiliary electrical equipment. Such an operation mode shall be determined, if necessary, through consultation with the manufacturer. Equipments (e.g. wheel chocks) that prevent the vehicle movement may be used as appropriate to ensure the safety during the test;
- (b) The REESS shall be discharged by the operation of electrical equipment, air-conditioning, heating, lighting, audio-visual equipment, etc., that can be switched on under the conditions given in

paragraph 6.2.7.3.2.2.(a). The operation shall be terminated when the vehicle's over-discharge protection control terminates REESS discharge current or the temperature of the REESS is stabilised such that the temperature varies by a gradient of less than 4 °C through 2 h. Where an over-discharge protection control fails to operate, or if there is no such control, then the discharging shall be continued until the REESS is discharged to 25 per cent of its nominal voltage level;

- (c) Immediately after the termination of discharging, one standard charge followed by a standard discharge as described in paragraph 6.2.1.1. shall be conducted if it is not prohibited by the vehicle.

6.2.7.3.2.3. Discharge of REESS using discharge resistor (vehicle-based test).

This procedure is applicable to vehicles for which the manufacturer provides information to connect a breakout harness to a location just outside the REESS that permits discharging the REESS:

- (a) Connect the breakout harness to the vehicle as specified by the manufacturer. Place the vehicle in active driving possible mode;
- (b) A discharge resistor is connected to the breakout harness and the REESS shall be discharged at a discharge rate under normal operating conditions in accordance with manufacturer provided information. A resistor with discharge power of 1 kW may be used;
- (c) The test shall be terminated when the vehicle's over-discharge protection control terminates REESS discharge current or the temperature of the REESS is stabilized such that the temperature varies by a gradient of less than 4 °C through 2 hours. Where an automatic discharge interrupt function fails to operate, or if there is no such function, then the discharging shall be continued until the REESS is discharged to 25 per cent of its nominal voltage level;
- (d) Immediately after the termination of discharging, one standard charge followed by a standard discharge as described in paragraph 6.2.1.1. shall be conducted if it is not prohibited by the vehicle.

6.2.7.3.2.4. Discharge by external equipment (component-based test).

This procedure is applicable to component-based test:

- (a) All relevant main contactors shall be closed. The external charge-discharge shall be connected to the main terminals of the Tested-Device;
- (b) A discharge shall be performed with a stable current within the normal operating range as specified by the manufacturer;
- (c) The discharging shall be continued until the Tested-Device (automatically) terminates REESS discharge current or the temperature of the Tested-Device is stabilised such that the temperature varies by a gradient of less than 4 °C through 2 hours. Where an automatic interrupt function fails to operate, or if there is no such function, then the discharging shall be continued until the Tested-Device is discharged to 25 per cent of its nominal voltage level;
- (d) Immediately after the termination of the discharging, one standard charge followed by a standard discharge as described in paragraph 6.2.1.1. shall be conducted if not inhibited by the Tested-Device.

- 6.2.7.4. The test shall end with an observation period of 1 hour at the ambient temperature conditions of the test environment.
- 6.2.8. Over-temperature protection test.
- 6.2.8.1. Purpose.
- The purpose of this test is to verify the performance of the protection measures of the REESS against internal overheating during operation. In the case that no specific protection measures are necessary to prevent the REESS from reaching an unsafe state due to internal over-temperature, this safe operation must be demonstrated.
- 6.2.8.2. The test may be conducted with a complete REESS according to paragraphs 6.2.8.3. and 6.2.8.4. or with a complete vehicle according to paragraphs 6.2.8.5. and 6.2.8.6.
- 6.2.8.3. Installation for test conducted using a complete REESS.
- 6.2.8.3.1. Ancillary systems that do not influence to the test results may be omitted from the Tested-Device. The test may be performed with a modified Tested-Device provided these modifications shall not influence the test results.
- 6.2.8.3.2. Where a REESS is fitted with a cooling function and where the REESS will remain functional in delivering its normal power without a cooling function system being operational, the cooling system shall be deactivated for the test.
- 6.2.8.3.3. The temperature of the Tested-Device shall be continuously measured inside the casing in the proximity of the cells during the test in order to monitor the changes of the temperature. The on-board sensors, if existing, may be used with compatible tools to read the signal.
- 6.2.8.3.4. The REESS shall be placed in a convective oven or climatic chamber. If necessary, for conduction the test, the REESS shall be connected to the rest of vehicle control system with extended cables. An external charge/discharge equipment may be connected under supervision by the vehicle manufacturer.
- 6.2.8.4. Test procedures for test conducted using a complete REESS.
- 6.2.8.4.1. At the beginning of the test, all protection devices which affect the function of the Tested-Device and are relevant to the outcome of the test shall be operational, except for any system deactivation implemented in accordance with paragraph 6.2.8.3.2.
- 6.2.8.4.2. The Tested-Device shall be continuously charged and discharged by the external charge/discharge equipment with a current that will increase the temperature of cells as rapidly as possible within the range of normal operation as defined by the manufacturer until the end of the test. Alternatively, the charge and discharge may be conducted by vehicle driving operations on chassis dynamometer where the driving operation shall be determined through consultation with the manufacturer to achieve the conditions above.
- 6.2.8.4.3. The temperature of the chamber or oven shall be gradually increased, from 20 ± 10 °C or at higher temperature if requested by the manufacturer, until it reaches the temperature determined in accordance with paragraph 6.2.8.4.3.1. or paragraph 6.2.8.4.3.2. below as applicable, and then maintained at a temperature that is equal to or higher than this, until the end of the test.

- 6.2.8.4.3.1. Where the REESS is equipped with protective measures against internal overheating, the temperature shall be increased to the temperature defined by the manufacturer as being the operational temperature threshold for such protective measures, to insure that the temperature of the Tested-Device will increase as specified in paragraph 6.2.8.4.2.
- 6.2.8.4.3.2. Where the REESS is not equipped with any specific measures against internal over-heating the temperature shall be increased to the maximum operational temperature specified by the manufacturer.
- 6.2.8.4.4. The test will end when one of the followings is observed:
- (a) The Tested-Device inhibits and/or limits the charge and/or discharge to prevent the temperature increase;
 - (b) The temperature of the Tested-Device is stabilised such that the temperature varies by a gradient of less than 4 °C through 2 hours;
 - (c) Any failure of the acceptance criteria prescribed in paragraph 5.4.8.
- 6.2.8.5. Installation for test conducted using a complete vehicle.
- 6.2.8.5.1. Based on information from the manufacturer, for an REESS fitted with a cooling function the cooling system shall be disabled or in a state of significantly reduced operation (for an REESS that will not operate if the cooling system is disabled) for the test.
- 6.2.8.5.2. The temperature of the REESS shall be continuously measured inside the casing in the proximity of the cells during the test in order to monitor the changes of the temperature using on-board sensors and compatible tools according to manufacturer provided information to read the signals.
- 6.2.8.5.3. For vehicles with on-board energy conversion systems, adjust the fuel level to nearly empty but so that the vehicle can enter into active driving possible mode.
- 6.2.8.5.4. The vehicle shall be placed in in a climate control chamber set to a temperature between 40 °C to 45 °C for at least 6 hours.
- 6.2.8.6. Test procedures for test conducted using a complete vehicle.
- 6.2.8.6.1. The vehicle shall be continuously charged and discharged in a manner that will increases the temperature of REESS cells as rapidly as possible within the range of normal operation as defined by the manufacturer until the end of the test.
- The charge and discharge will be conducted by vehicle driving operations on chassis dynamometer where the driving operation shall be determined through consultation with the manufacturer to achieve the conditions above.
- For a vehicle that can be charged by an external power supply, the charging may be conducted using an external power supply if more rapid temperature increase is expected.
- 6.2.8.6.2. The test will end when one of the followings is observed:
- (a) The vehicle terminates the charge and/or discharge;
 - (b) The temperature of the REESS is stabilised such that the temperature varies by a gradient of less than 4 °C through 2 hours;
 - (c) Any failure of the acceptance criteria prescribed in paragraph 5.4.8.;

- (d) 3 hours elapse from the time of starting the charge/discharge cycles in paragraph 6.2.8.6.1.
- 6.2.9. Overcurrent protection test.
- 6.2.9.1. Purpose.
- The purpose of this test is to verify the performance of the overcurrent protection during DC external charging to prevent the REESS from any severe events caused by excessive levels of charge current as specified by the manufacturer.
- 6.2.9.2. Test conditions:
- (a) The test shall be conducted at an ambient temperature of 20 ± 10 °C;
- (b) The SOC of REESS shall be adjusted around the middle of normal operating range by normal operation recommended by the manufacturer such as driving the vehicle or using an external charger. The accurate adjustment is not required as long as the normal operation of the REESS is enabled;
- (c) The overcurrent level (assuming failure of external DC electricity supply equipment) and maximum voltage (within normal range) that can be applied shall be determined, if necessary, through consultation with the manufacturer.
- 6.2.9.3. The overcurrent test shall be conducted in accordance with paragraph 6.2.9.4. or paragraph 6.2.9.5., as applicable and in accordance with manufacturer information.
- 6.2.9.4. Overcurrent during charging by external electricity supply.
- This test procedure is applicable to vehicle-based test for vehicles that have the capability of charging by DC external electricity supply:
- (a) The DC charging vehicle inlet shall be used for connecting the external DC electricity supply equipment. The charge control communication of the external electricity supply equipment is altered or disabled to allow the overcurrent level determined through consultation with the manufacturer;
- (b) Charging of the REESS by the external DC electricity supply equipment shall be initiated to achieve the highest normal charge current specified by the manufacturer. The charge current is then increased over 5 s from the highest normal charge current to the overcurrent level determined in accordance with paragraph 6.2.9.2.(c) above. Charging is then continued at this overcurrent level;
- (c) The charging shall be terminated when the functionality of the vehicle's overcurrent protection terminates the REESS charge current or the temperature of the REESS is stabilised such that the temperature varies by a gradient of less than 4 °C through 2 hours;
- (d) Immediately after the termination of charging, one standard cycle as described in paragraph 6.2.1.1. shall be conducted, if it is not prohibited by the vehicle.

6.2.9.5. Overcurrent during charging using breakout harness.

This test procedure is applicable to vehicles that have the capability of charging by DC external electricity supply and for which the manufacturer provides information to connect a breakout harness to a location just outside the REESS that permits charging of the REESS:

- (a) The breakout harness is connected to the vehicle as specified by the manufacturer;
- (b) The external electricity supply equipment along with the overcurrent supply is connected to the breakout harness and charging of the REESS is initiated to achieve the highest normal charge current specified by the manufacturer;
- (c) The charge current is then increased over 5 seconds from the highest normal charge current to the overcurrent level determined in accordance with paragraph 6.2.9.2.(c) above. Charging is then continued at this overcurrent level;
- (d) The charging shall be terminated when the functionality of the vehicle's overcurrent protection terminates charging or the temperature of the Tested-Device is stabilised such that the temperature varies by a gradient of less than 4 °C through 2 hours;
- (e) Immediately after the termination of charging, one standard cycle as described in paragraph 6.2.1.1. shall be conducted, if it is not prohibited by the vehicle.

6.2.9.6. The test shall end with an observation period of 1 hour at the ambient temperature conditions of the test environment.

6.2.10. Mechanical shock test.

6.2.10.1. Purpose.

The purpose of this test is to verify the safety performance of the REESS under inertial loads which may occur during a vehicle crash.

6.2.10.2. Installations.

6.2.10.2.1. This test shall be conducted either with the complete REESS or with REESS subsystem(s). If the manufacturer chooses to test with REESS subsystem(s), the manufacturer shall demonstrate that the test result can reasonably represent the performance of the complete REESS with respect to its safety performance under the same conditions. If the electronic management unit for the REESS is not integrated in the casing enclosing the cells, then the electronic management unit may be omitted from installation on the Tested-Device if so requested by the manufacturer.

6.2.10.2.2. The Tested-Device shall be connected to the test fixture only by the intended mountings provided for the purpose of attaching the REESS or REESS subsystem to the vehicle.

6.2.10.3. Procedures.

6.2.10.3.1. General test conditions and requirements.

The following condition shall apply to the test:

- (a) the test shall be conducted at an ambient temperature of 20 ± 10 °C;

- (b) at the beginning of the test, the SOC shall be adjusted in accordance with the paragraph 6.2.1.2.;
- (c) at the beginning of the test, all protection devices which affect the function of the Tested-Device and which are relevant to the outcome of the test, shall be operational.

6.2.10.3.2. Test procedure.

The Tested-Device shall be decelerated or accelerated in compliance with the acceleration corridors which are specified in Figure 14 and Tables 3 or 4. The manufacturer shall decide whether the tests shall be conducted in either the positive or negative direction or both.

For each of the test pulses specified, a separate Tested-Device may be used.

The test pulse shall be within the minimum and maximum value as specified in Tables 3 or 4. A higher shock level and /or longer duration as described in the maximum value in Tables 3 or 4 can be applied to the Tested-Device if recommended by the manufacturer.

The test shall end with an observation period of 1 h at the ambient temperature conditions of the test environment.

Figure 14
Generic description of test pulses

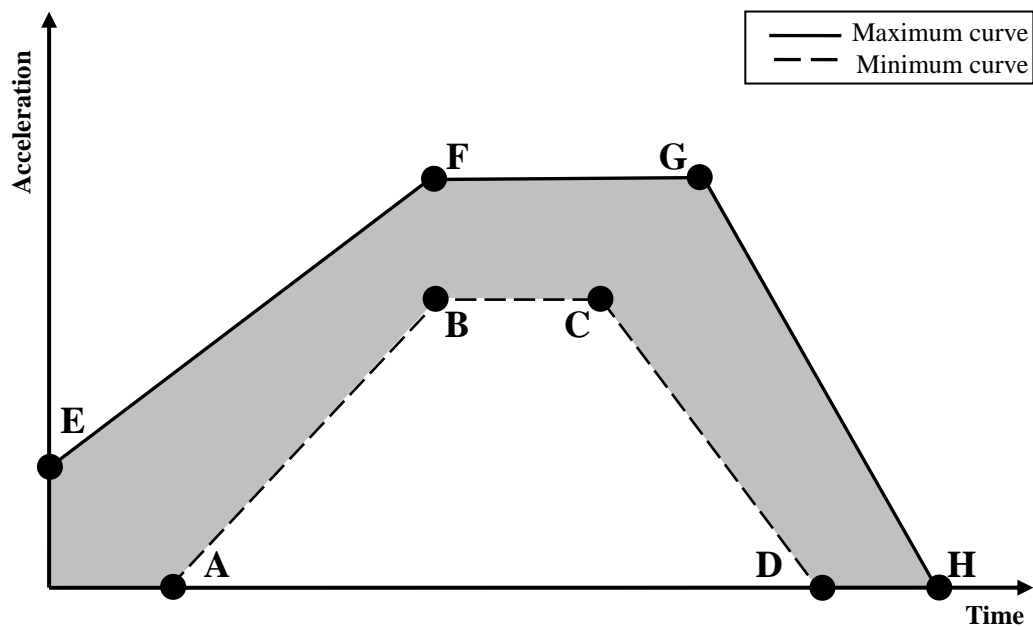

Table 3
Values for category 1-1 vehicles and category 2 vehicles with GVM≤3.5t

<i>Point</i>	<i>Time (ms)</i>	<i>Acceleration (g)</i>	
		Longitudinal	Transverse
A	20	0	0
B	50	20	8
C	65	20	8
D	100	0	0
E	0	10	4.5
F	50	28	15
G	80	28	15
H	120	0	0

Table 4
Values for category 1-2 vehicles and category 2 vehicles with GVM>3.5t

<i>Point</i>	<i>Time (ms)</i>	<i>Acceleration (g)</i>	
		Longitudinal	Transverse
A	20	0	0
B	50	10	5
C	65	10	5
D	100	0	0
E	0	5	2.5
F	50	17	10
G	80	17	10
H	120	0	0

6.2.11. Mechanical integrity test.

6.2.11.1. Purpose.

The purpose of this test is to verify the safety performance of the REESS under contact loads which may occur during vehicle crash situation.

6.2.11.2. Installations.

6.2.11.2.1. This test shall be conducted with either the complete REESS or with REESS subsystem(s). If the manufacturer chooses to test with REESS subsystem(s), the manufacturer shall demonstrate that the test result can reasonably represent the performance of the complete REESS with respect to its safety performance under the same conditions. If the electronic management unit for the REESS is not integrated to the casing enclosing the cells, then the electronic management unit may be omitted from installation on the Tested-Device if so requested by the manufacturer.

6.2.11.2.2. The Tested-Device shall be connected to the test fixture as recommended by the manufacturer.

6.2.11.3. Procedures.

6.2.11.3.1. General test conditions.

The following condition and requirements shall apply to the test:

- (a) The test shall be conducted at an ambient temperature of 20 ± 10 °C;
- (b) At the beginning of the test, the SOC shall be adjusted in accordance with the paragraph 6.2.1.2.;
- (c) At the beginning of the test, all internal and external protection devices which would affect the function of the Tested-Device and which are relevant to the outcome of the test shall be operational;
- (d) Vehicle body structure, electrical protection barriers, enclosures, or other mechanical protection functional devices against contact force regardless outside or inside of the REESS may be attached to the Tested-Device if so requested by the manufacturer. The manufacturer shall define the relevant parts used for the mechanical protection of the REESS. The test may be conducted with the REESS mounted to this vehicle structure in a way which is representative of its mounting in the vehicle.

6.2.11.3.2 Crush test.

6.2.11.3.2.1. Crush force.

The Tested-Device shall be crushed between a resistance and a crush plate as described in Figure 15 with a force of at least 100 kN but not exceeding 105 kN unless otherwise specified in accordance with paragraph 5.5.2.1., with an onset time less than 3 minutes and a hold time of at least 100 ms but not exceeding 10 s.

A higher crush force, a longer onset time, a longer hold time, or a combination of these, may be applied at the request of the manufacturer.

The application of the force shall be decided by the manufacturer having consideration to the direction of travel of the REESS relative to its installation in the vehicle. The application force being applied horizontally and perpendicular to the direction of travel of the REESS.

The test shall end with an observation period of 1 h at the ambient temperature conditions of the test environment.

Figure 15

Dimension of the crush plate

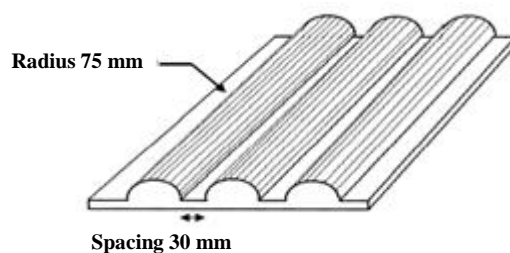

Dimension of the crush plate:
600 mm x 600 mm or smaller

7. Heavy duty vehicles – Performance requirements

7.1. Requirements of a vehicle with regard to its electrical safety - in-use.

7.1.1. Protection against electric shock.

These electrical safety requirements apply to high voltage buses under conditions where they are not connected to the external electric power supply.

7.1.1.1. Protection against direct contact.

High voltage live parts shall comply with paragraphs 7.1.1.1.1. and 7.1.1.1.2. for protection against direct contact. Conductive connection devices not energized except during charging of the REESS are exempted from this requirement if located on the roof of the vehicle out of reach for a person standing outside of the vehicle. For Category 1-2 vehicles, the minimum wrap around distance from the instep of the vehicle to the roof mounted charging devices is 3.00 m. In case of multiple steps due to elevated floor inside the vehicle, the wrap around distance is measured from the bottom most step at entry, as illustrated in Figure 16.

Electrical protection barriers, enclosures, solid insulators and connectors shall not be opened, disassembled or removed e.g. without the use of tools, an operator controlled activation/deactivation device, or equivalent.

However, connectors (including the vehicle inlet) are allowed to be separated without the use of tools, if they meet one or more of the following requirements:

- (a) They comply with paragraphs 7.1.1.1.1. and 7.1.1.1.2. when separated; or
- (b) They are provided with a locking mechanism (at least two distinct actions are needed to separate the connector from its mating component). Additionally, other components, not being part of the connector, shall be removable only with the use of tools, an operator controlled activation/deactivation device or equivalent, in order to be able to separate the connector; or
- (c) The voltage of the live parts becomes equal or below 60V DC or equal or below 30V AC (rms) within 1s after the connector is separated.

Figure 16
Schematics of how to measure wrap-around distance

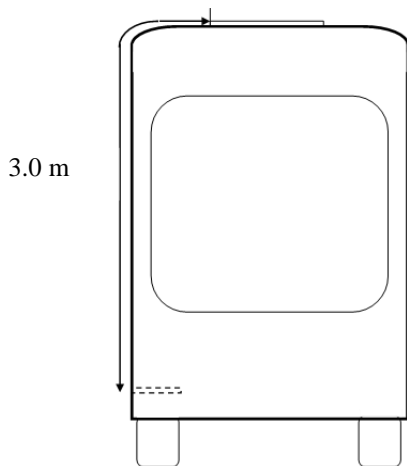

- 7.1.1.1.1. For high voltage live parts inside the passenger compartment or luggage compartment, the protection degree IPXXD shall be provided.
- 7.1.1.1.2. For high voltage live parts in areas other than the passenger compartment or luggage compartment, the protection degree IPXXB shall be provided.
- 7.1.1.1.3. Service disconnect.
For a high voltage service disconnect which can be opened, disassembled or removed without the use of tools or an operator controlled activation/deactivation device, or equivalent, protection IPXXB degree shall be satisfied when it is opened, disassembled or removed as intended by the system design.
- 7.1.1.1.4. Marking.
- 7.1.1.1.4.1. The symbol shown in Figure 17 shall be present on or near the REESS having high voltage capability. The symbol background shall be yellow, the bordering and the arrow shall be black.
This requirement shall also apply to a REESS which is part of a galvanically connected electrical circuit where the specific voltage condition is not fulfilled, independent of the maximum voltage of the REESS.

Figure 17

Marking of high voltage equipment

- 7.1.1.1.4.2. The symbol shall be visible on enclosures and electrical protection barriers, which, when removed, expose live parts of high voltage circuits. This provision is optional to any connectors for high voltage buses. This provision shall not apply to the cases:
- (a) Where electrical protection barriers or enclosures cannot be physically accessed, opened, or removed; unless other vehicle components are removed with the use of tools, using an operator controlled activation/deactivation device, or equivalent, or
 - (b) Where electrical protection barriers or enclosures are located underneath the vehicle floor.
- 7.1.1.1.4.3. Cables for high voltage buses which are not located within enclosures shall be identified by having an outer covering with the colour orange.
- 7.1.1.2. Protection against indirect contact.
- 7.1.1.2.1. For protection against electric shock which could arise from indirect contact, the exposed conductive parts, such as the conductive electrical protection barrier and enclosure, shall be conductively connected and secured to the electrical chassis with electrical wire or ground cable, by welding, or by connection using bolts, etc. so that no dangerous potentials are produced.
- 7.1.1.2.2. The resistance between all exposed conductive parts and the electrical chassis shall be lower than 0.1Ω when there is current flow of at least 0.2 A .

The resistance between any two simultaneously reachable exposed conductive parts of the electrical protection barriers that are less than 2.5 m from each other shall not exceed 0.2 Ω . This resistance may be calculated using the separately measured resistances of the relevant parts of electric path.

This requirement is satisfied if the connection has been established by welding. In case of doubts or the connection is established by other means than welding, a measurement shall be made by using one of the test procedures described in paragraph 8.1.4.

- 7.1.1.2.3. In the case of motor vehicles which are intended to be connected to the grounded external electric power supply through the conductive connection, a device to enable the conductive connection of the electrical chassis to the earth ground for the external electric power supply shall be provided.

The device shall enable connection to the earth ground before exterior voltage is applied to the vehicle and retain the connection until after the exterior voltage is removed from the vehicle.

Compliance to this requirement may be demonstrated either by using the connector specified by the car manufacturer, by visual inspection or drawings.

The above requirements are only applicable for vehicles when charging from a fixed, dedicated charging point, with a harness of a maximum length, through a vehicle connector containing a plug and an inlet.

- 7.1.1.2.4. Isolation resistance.

This paragraph shall not apply to electrical circuits that are galvanically connected to each other, where the DC part of these circuits is connected to the electrical chassis and the specific voltage condition is fulfilled.

- 7.1.1.2.4.1. Electric power train consisting of separate DC or AC buses.

If AC high voltage buses and DC high voltage buses are conductively isolated from each other, isolation resistance between the high voltage bus and the electrical chassis shall have a minimum value of 100 Ω/V of the working voltage for DC buses, and a minimum value of 500 Ω/V of the working voltage for AC buses.

The measurement shall be conducted according to paragraph 8.1.1.

- 7.1.1.2.4.2. Electric power train consisting of combined DC- and AC-buses.

If AC high voltage buses and DC high voltage buses are conductively connected, isolation resistance between the high voltage bus and the electrical chassis shall have a minimum value of 500 Ω/V of the working voltage.

However, if all AC high voltage buses are protected by one of the two following measures, isolation resistance between the high voltage bus and the electrical chassis shall have a minimum value of 100 Ω/V of the working voltage:

- (a) At least two or more layers of solid insulators, electrical protection barriers or enclosures that meet the requirement in paragraph 7.1.1.1. independently, for example wiring harness, or

- (b) Mechanically robust protections that have sufficient durability over vehicle service life such as motor housings, electronic converter cases or connectors.

The isolation resistance between the high voltage bus and the electrical chassis may be demonstrated by calculation, measurement or a combination of both.

The measurement shall be conducted according to paragraph 8.1.1.

7.1.1.2.4.3. Fuel cell vehicles.

In fuel cell vehicles, DC high voltage buses shall have an on-board isolation resistance monitoring system together with a warning to the driver if the isolation resistance drops below the minimum required value of 100 Ω/V . The function of the on-board isolation resistance monitoring system shall be confirmed as described in paragraph 8.1.2.

The isolation resistance between the high voltage bus of the coupling system for charging the REESS, which is not energized in conditions other than that during the charging of the REESS, and the electrical chassis need not to be monitored.

7.1.1.2.4.4. Isolation resistance requirement for the coupling system for charging the REESS.

For the vehicle conductive connection device intended to be conductively connected to the external AC electric power supply and the electrical circuit that is conductively connected to the vehicle conductive connection device during charging of the REESS, the isolation resistance between the high voltage bus and the electrical chassis shall comply with the requirements of paragraph 7.1.1.2.4.1. when the vehicle connector is disconnected and the isolation resistance is measured at the high voltage live parts (contacts) of the vehicle conductive connection device. During the measurement, the REESS may be disconnected.

The measurement shall be conducted according to paragraph 8.1.1.

7.1.1.3. Protection against water effects.

The vehicles shall maintain isolation resistance after exposure to water (e.g. washing, driving through standing water). This paragraph shall not apply to electrical circuits that are galvanically connected to each other, where the DC part of these circuits is connected to the electrical chassis and the specific voltage condition is fulfilled.

7.1.1.3.1. The vehicle manufacturer can choose to comply with requirements specified in paragraph 7.1.1.3.2. or those specified in paragraph 7.1.1.3.3.

7.1.1.3.2. The vehicle manufacturers shall provide evidence and/or documentation to the regulatory or testing entity as applicable on how the electrical design or the components of the vehicle located outside the passenger compartment or externally attached, after water exposure remain safe and comply with the requirements described in Annex 2. If the evidence and/or documentation provided is not satisfactory the regulatory or testing entity as applicable shall require the manufacturer to perform a physical component test based on the same specifications as those described in Annex 2.

7.1.1.3.3. If the test procedures specified in paragraph 8.1.5. are performed, just after each exposure, and with the vehicle still wet, the vehicle shall then comply

with isolation resistance test given in paragraph 8.1.1., and the isolation resistance requirements given in paragraph 7.1.1.2.4. shall be met. In addition, after a 24 hour pause, the isolation resistance test specified in paragraph 8.1.1. shall again be performed, and the isolation resistance requirements given in paragraph 7.1.1.2.4. shall be met.

A representative vehicle shall be selected for testing and a compliant test result for this vehicle shall constitute evidence of compliance for all variations of vehicles, provided that the REESS and the REESS installation on the vehicles are the same.

- 7.1.1.3.4. Each Contracting Party may elect to adopt the following requirement as an alternative to the requirements in paragraph 7.1.1.3.1.

If an isolation resistance monitoring system is provided, and the isolation resistance less than the requirements given in paragraph 7.1.1.2.4. is detected, a warning shall be indicated to the driver. The function of the on-board isolation resistance monitoring system shall be confirmed as described in paragraph 8.1.2.

- 7.1.2. Functional safety.

- 7.1.2.1. At least a momentary indication shall be given to the driver each time when the vehicle is first placed in "active driving possible mode" after manual activation of the propulsions system.

However, this provision does not apply under conditions where an internal combustion engine provides directly or indirectly the vehicle's propulsion power upon start up.

- 7.1.2.2. When leaving the vehicle, the driver shall be informed by a signal (e.g. optical or audible signal) if the vehicle is still in the active driving possible mode.

- 7.1.2.3. The state of the drive direction control unit shall be identified to the driver.

- 7.1.2.4. If the REESS can be externally charged, vehicle movement by its own propulsion system shall be impossible as long as the connector of the external electric power supply is physically connected to the vehicle conductive connection device.

This requirement shall be demonstrated by using the connector specified by the vehicle manufacturer.

The above requirement are only applicable for vehicles when charging from a fixed, dedicated charging point, with a harness of a maximum length, through a vehicle connector containing a plug and inlet.

- 7.2. Requirements with regard to installation and functionality of REESS in a vehicle

- 7.2.1. Installation of REESS on a vehicle.

For installation of REESS on a vehicle, the requirement of either paragraph 7.2.1.1. or paragraph 7.2.1.2. shall be satisfied.

- 7.2.1.1. The REESS shall comply with the respective requirements of paragraph 7.3., taking account of the installed conditions on a specific type of vehicle.

- 7.2.1.2. For a REESS which satisfies the requirements of paragraph 7.3. independently from the type of vehicles, the REESS shall be installed on the

vehicle in accordance with the instructions provided by the manufacturer of the REESS.

- 7.2.2. Warning in the event of operational failure of vehicle controls that manage REESS safe operation.

The vehicle shall provide a warning to the driver when the vehicle is in active driving possible mode in the event of operational failure of the vehicle controls that manage the safe operation of the REESS. Vehicle manufacturers shall make available, at the request of the regulatory or testing entity as applicable with its necessity, the following documentation explaining safety performance of the system level or sub-system level of the vehicle:

- 7.2.2.1. A system diagram that identifies all the vehicle controls that manage REESS operations. The diagram must identify what components are used to generate a warning due to operational failure of vehicle controls to conduct one or more basic operations.

- 7.2.2.2. A written explanation describing the basic operation of the vehicle controls that manage REESS operation. The explanation must identify the components of the vehicle control system, provide description of their functions and capability to manage the REESS, and provide a logic diagram and description of conditions that would lead to triggering of the warning.

In case of optical warning, the tell-tale shall, when illuminated, be sufficiently bright to be visible to the driver under both daylight and night-time driving conditions, when the driver has adapted to the ambient roadway light conditions.

This tell-tale shall be activated as a check of lamp function either when the propulsion system is turned to the "On" position, or when the propulsion system is in a position between "On" and "Start" that is designated by the manufacturer as a check position. This requirement does not apply to the tell-tale or text shown in a common space.

- 7.2.3. Warning in the case of a thermal event within the REESS.

The vehicle shall provide a warning to the driver in the case of a thermal event in the REESS (as specified by the manufacturer) when the vehicle is in active driving possible mode. Vehicle manufacturers shall make available, at the request of the regulatory or testing entity as applicable with its necessity, the following documentation explaining safety performance of the system level or sub-system level of the vehicle:

- 7.2.3.1. The parameters and associated threshold levels that are used to indicate a thermal event (e.g. temperature, temperature rise rate, SOC level, voltage drop, electrical current, etc.) to trigger the warning.

- 7.2.3.2. A system diagram and written explanation describing the sensors and operation of the vehicle controls to manage the REESS in the event of a thermal event.

In case of optical warning, the tell-tale shall, when illuminated, be sufficiently bright to be visible to the driver under both daylight and night-time driving conditions, when the driver has adapted to the ambient roadway light conditions.

This warning tell-tale shall be activated as a check of lamp function either when the propulsion system is turned to the "On" position, or when the

propulsion system is in a position between "On" and "Start" that is designated by the manufacturer as a check position. This requirement does not apply to the optical signal or text shown in a common space.

7.2.4. Warning in the event of low energy content of REESS.

For BEVs (vehicles in which propulsion system are powered only by a REESS), a warning to the driver in the event of low REESS state of charge shall be provided. Based on engineering judgment, the manufacturer shall determine the necessary level of REESS energy remaining, when the driver warning is first provided.

In case of optical warning, the tell-tale shall, when illuminated, be sufficiently bright to be visible to the driver under both daylight and night-time driving conditions, when the driver has adapted to the ambient roadway light conditions.

7.3 Requirements with regard to the safety of REESS - in-use.

7.3.1. General principle.

The requirements of paragraphs 7.3.2. to 7.3.12. shall be checked in accordance with the methods set out in paragraph 8.2.

7.3.2. Vibration.

The test shall be conducted in accordance with paragraph 8.2.2.

During the test, there shall be no evidence of electrolyte leakage, rupture (applicable to high voltage REESS only), venting (for REESS other than open-type traction battery), fire or explosion.

The evidence of electrolyte leakage shall be verified by visual inspection without disassembling any part of the Tested-Device. An appropriate technique shall, if necessary, be used in order to confirm if there is any electrolyte leakage from the REESS resulting from the test. The evidence of venting shall be verified by visual inspection without disassembling any part of the Tested-Device.

For a high voltage REESS, the isolation resistance measured after the test in accordance with paragraph 8.1.1. shall not be less than 100 Ω/V .

7.3.3. Thermal shock and cycling.

The test shall be conducted in accordance with paragraph 8.2.3.

During the test, there shall be no evidence of electrolyte leakage, rupture (applicable to high voltage REESS only), venting (for REESS other than open-type traction battery), fire or explosion.

The evidence of electrolyte leakage shall be verified by visual inspection without disassembling any part of the Tested-Device. An appropriate technique shall, if necessary, be used in order to confirm if there is any electrolyte leakage from the REESS resulting from the test. The evidence of venting shall be verified by visual inspection without disassembling any part of the Tested-Device.

For a high voltage REESS, the isolation resistance measured after the test in accordance with paragraph 8.1.1. shall not be less than 100 Ω/V .

7.3.4. Fire resistance.

The test shall be conducted in accordance with paragraph 8.2.4.

This test is required for REESS containing flammable electrolyte.

This test is not required when the REESS as installed in the vehicle, is mounted such that the lowest surface of the casing of the REESS is more than 1.5 m above the ground. At the choice of the manufacturer, this test may be performed where the lower surface of the REESS's is higher than 1.5 m above the ground. The test shall be carried out on one test sample.

During the test, the Tested-Device shall exhibit no evidence of explosion.

7.3.5. External short circuit protection.

The test shall be conducted in accordance with paragraph 8.2.5.

During the test there shall be no evidence of; electrolyte leakage, rupture (applicable to high voltage REESS only), venting (for REESS other than open-type traction battery), fire or explosion.

The evidence of electrolyte leakage shall be verified by visual inspection without disassembling any part of the Tested-Device. An appropriate technique shall, if necessary, be used in order to confirm if there is any electrolyte leakage from the REESS resulting from the test. The evidence of venting shall be verified by visual inspection without disassembling any part of the Tested-Device.

The REESS's short circuit protection control shall terminate the short circuit current, or the temperature measured on the casing of the tested-device or the REESS shall be stabilized, such that the temperature gradient varies by less than 4 °C through 2 h after introducing the short circuit.

For a high voltage REESS, the isolation resistance measured after the test in accordance with paragraph 8.1.1. shall not be less than 100 Ω/V.

7.3.6. Overcharge protection.

The test shall be conducted in accordance with paragraph 8.2.6.

During the test there shall be no evidence of electrolyte leakage, rupture (applicable to high voltage REESS only), venting (for REESS other than open-type traction battery), fire or explosion.

The evidence of electrolyte leakage shall be verified by visual inspection without disassembling any part of the Tested-Device. An appropriate technique shall, if necessary, be used in order to confirm if there is any electrolyte leakage from the REESS resulting from the test. The evidence of venting shall be verified by visual inspection without disassembling any part of the Tested-Device.

For a high voltage REESS, the isolation resistance measured after the test in accordance with paragraph 8.1.1. shall not be less than 100 Ω/V.

7.3.7. Over-discharge protection.

The test shall be conducted in accordance with paragraph 8.2.7.

During the test there shall be no evidence of; electrolyte leakage, rupture (applicable to high voltage REESS only), venting (for REESS other than open-type traction battery), fire or explosion.

The evidence of electrolyte leakage shall be verified by visual inspection without disassembling any part of the Tested-Device. An appropriate technique shall, if necessary, be used in order to confirm if there is any electrolyte leakage from the REESS resulting from the test. The evidence of venting shall be verified by visual inspection without disassembling any part of the Tested-Device.

For a high voltage REESS, the isolation resistance measured after the test in accordance with paragraph 8.1.1. shall not be less than 100 Ω/V .

7.3.8. Over-temperature protection.

The test shall be conducted in accordance with paragraph 8.2.8.

During the test there shall be no evidence of; electrolyte leakage, rupture (applicable to high voltage REESS only), venting (for REESS other than open-type traction battery), fire or explosion.

The evidence of electrolyte leakage shall be verified by visual inspection without disassembling any part of the Tested-Device. An appropriate technique shall, if necessary, be used in order to confirm if there is any electrolyte leakage from the REESS resulting from the test. The evidence of venting shall be verified by visual inspection without disassembling any part of the Tested-Device.

For a high voltage REESS, the isolation resistance measured after the test in accordance with paragraph 8.1.1. shall not be less than 100 Ω/V .

7.3.9. Reserved.

7.3.10. Low-temperature protection.

Vehicle manufacturers must make available, at the request of the regulatory or testing entity as applicable with its necessity, the following documentations explaining safety performance of the system level or sub-system level of the vehicle to demonstrate that the vehicle monitors and appropriately controls REESS operations at low temperatures at the safety boundary limits of the REESS:

- (a) A system diagram;
- (b) Written explanation on the lower boundary temperature for safe operation of REESS;
- (c) Method of detecting REESS temperature;
- (d) Action taken when the REESS temperature is at or lower than the lower boundary for safe operation of the REESS.

7.3.11. Management of gases emitted from REESS.

7.3.11.1. Under vehicle operation including the operation with a failure, the vehicle occupants shall not be exposed to any hazardous environment caused by emissions from REESS.

7.3.11.2. For the open-type traction battery, requirement of paragraph 7.3.11.1. shall be verified by following test procedure.

7.3.11.2.1. The test shall be conducted following the method described in Annex 1 of this regulation. The hydrogen sampling and analysis shall be the ones prescribed. Other analysis methods can be approved if it is proven that they give equivalent results.

- 7.3.11.2.2. During a normal charge procedure in the conditions given in Annex 1, hydrogen emissions shall be below 125 g during 5 hours, or below $25 \times t_2$ g during t_2 (in h) where t_2 is the time of overcharging at constant current.
- 7.3.11.2.3. During a charge carried out by a charger presenting a failure (conditions given in Annex 1), hydrogen emissions shall be below 42 g. Furthermore, the charger shall limit this possible failure to 30 minutes.
- 7.3.11.3. For REESS other than open-type traction battery, the requirement of paragraph 7.3.11.1. is deemed to be satisfied, if all requirements of the following tests are met: para. 8.2.2. (vibration), para. 8.2.3. (thermal shock and cycling), 8.2.5. (external short circuit protection), para. 8.2.6. (overcharge protection), para. 8.2.7. (over-discharge protection), para. 8.2.8. (over-temperature protection) and para. 8.2.9. (overcurrent protection).
- 7.3.12. Thermal propagation.
- For the vehicles equipped with a REESS containing flammable electrolyte, the vehicle occupants shall not be exposed to any hazardous environment caused by thermal propagation which is triggered by an internal short circuit leading to a single cell thermal runaway. To ensure this, the requirements of paragraphs 7.3.12.1. and 7.3.12.2. shall be satisfied.³
- 7.3.12.1. The vehicle shall provide an advance warning indication to allow egress or 5 minutes prior to the presence of a hazardous situation inside the passenger compartment caused by thermal propagation which is triggered by an internal short circuit leading to a single cell thermal runaway such as fire, explosion or smoke. This requirement is deemed to be satisfied if the thermal propagation does not lead to a hazardous situation for the vehicle occupants. This warning shall have characteristics in accordance with paragraph 7.2.3.2. The vehicle manufacturer shall make available, at the request of the regulatory or testing entity as applicable with its necessity, the following documentation explaining safety performance of the system level or sub-system level of the vehicle:
- 7.3.12.1.1. The parameters (for example, temperature, voltage or electrical current) which trigger the warning indication.
- 7.3.12.1.2. Description of the warning system.
- 7.3.12.2. The vehicle shall have functions or characteristics in the cell, REESS or vehicle intended to protect vehicle occupants (as described in paragraph 7.3.12.) in conditions caused by thermal propagation which is triggered by an internal short circuit leading to a single cell thermal runaway. Vehicle manufacturers shall make available, at the request of the regulatory or testing entity as applicable with its necessity, the following documentation explaining safety performance of the system level or sub-system level of the vehicle (see also paragraph 196 in Part 1, section E):
- 7.3.12.2.1. A risk reduction analysis using appropriate industry standard methodology (for example, IEC 61508, MIL-STD 882E, ISO 26262, AIAG DFMEA, fault analysis as in SAE J2929, or similar), which documents the risk to vehicle

³ In regions applying type-approval testing the manufacturer will be accountable for the verity and integrity of documentation submitted, assuming full responsibility for the safety of occupants against adverse effects arising from thermal propagation caused by internal short circuit. In regions applying self-certification responsibility is automatically borne by the manufacturer.

occupants caused by thermal propagation which is triggered by an internal short circuit leading to a single cell thermal runaway and documents the reduction of risk resulting from implementation of the identified risk mitigation functions or characteristics.

- 7.3.12.2.2. A system diagram of all relevant physical systems and components. Relevant systems and components are those which contribute to protection of vehicle occupants from hazardous effects caused by thermal propagation triggered by a single cell thermal runaway.
- 7.3.12.2.3. A diagram showing the functional operation of the relevant systems and components, identifying all risk mitigation functions or characteristics.
- 7.3.12.2.4. For each identified risk mitigation function or characteristic:
 - 7.3.12.2.4.1. A description of its operation strategy;
 - 7.3.12.2.4.2. Identification of the physical system or component which implements the function;
 - 7.3.12.2.4.3. One or more of the following engineering documents relevant to the manufacturers design which demonstrates the effectiveness of the risk mitigation function:
 - (a) Tests performed including procedure used and conditions and resulting data;
 - (b) Analysis or validated simulation methodology and resulting data.
- 7.4. Requirements with regard to the safety of REESS simulating inertial load.
- 7.4.1. Mechanical shock.

The test shall be conducted in accordance with paragraph 8.2.10.

During the test there shall be no evidence of electrolyte leakage, fire or explosion.

The evidence of electrolyte leakage shall be verified by visual inspection without disassembling any part of the Tested-Device. An appropriate technique shall, if necessary, be used in order to confirm if there is any electrolyte leakage from the REESS resulting from the test.

An appropriate coating, if necessary, may be applied to the physical protection (casing) in order to confirm if there is any electrolyte leakage from the REESS resulting from the test. Unless the manufacturer provides a means to differentiate between the leakage of different liquids, all liquid leakage shall be considered as the electrolyte.

After the test, the Tested-Device shall be retained by its mounting and its components shall remain inside its boundaries.

For a high voltage REESS, the isolation resistance of the Tested-Device shall ensure at least 100 Ω /Volt for the whole REESS measured after the test in accordance with paragraph 7.2.1., or the protection IPXXB shall be fulfilled for the Tested-Device when assessed in accordance with paragraph 8.1.3.

8. Heavy duty vehicles – Test procedures

8.1. Test procedures for electrical safety.

8.1.1. Isolation resistance measurement method

8.1.1.1. General.

The isolation resistance for each high voltage bus of the vehicle is measured or shall be determined by calculating the measurement values of each part or component unit of a high voltage bus.

8.1.1.2. Measurement method.

The isolation resistance measurement is conducted by selecting an appropriate measurement method from among those listed in paragraphs 8.1.1.2.1. to 8.1.1.2.2., depending on the electrical charge of the live parts or the isolation resistance.

Megohmmeter or oscilloscope measurements are appropriate alternatives to the procedure described below for measuring isolation resistance. In this case, it may be necessary to deactivate the on-board isolation resistance monitoring system.

The range of the electrical circuit to be measured is clarified in advance, using electrical circuit diagrams. If the high voltage buses are conductively isolated from each other, isolation resistance shall be measured for each electrical circuit.

If the operating voltage of the Tested-Device (V_b , Figure 18) cannot be measured (e.g. due to disconnection of the electric circuit caused by main contactors or fuse operation), the test may be performed with a modified Tested-Device to allow measurement of the internal voltages (upstream the main contactors).

Moreover, modifications necessary for measuring the isolation resistance may be carried out, such as removal of the cover in order to reach the live parts, drawing of measurement lines and change in software.

In cases where the measured values are not stable due to the operation of the on-board isolation resistance monitoring system, necessary modifications for conducting the measurement may be carried out by stopping the operation of the device concerned or by removing it. Furthermore, when the device is removed, a set of drawings will be used to prove that the isolation resistance between the live parts and the electrical chassis remains unchanged.

These modifications shall not influence the test results.

Utmost care shall be exercised to avoid short circuit and electric shock since this confirmation might require direct operations of the high-voltage circuit.

8.1.1.2.1. Measurement method using DC voltage from external sources.

8.1.1.2.1.1. Measurement instrument.

An isolation resistance test instrument capable of applying a DC voltage higher than the working voltage of the high voltage bus shall be used.

8.1.1.2.1.2. Measurement method.

An isolation resistance test instrument is connected between the live parts and the electrical chassis. The isolation resistance is subsequently measured

by applying a DC voltage at least half of the working voltage of the high voltage bus.

If the system has several voltage ranges (e.g. because of boost converter) in conductively connected circuit and some of the components cannot withstand the working voltage of the entire circuit, the isolation resistance between those components and the electrical chassis can be measured separately by applying at least half of their own working voltage with those components disconnected.

8.1.1.2.2. Measurement method using the vehicle's own REESS as DC voltage source.

8.1.1.2.2.1. Test vehicle conditions.

The high voltage-bus is energized by the vehicle's own REESS and/or energy conversion system and the voltage level of the REESS and/or energy conversion system throughout the test shall be at least the nominal operating voltage as specified by the vehicle manufacturer.

8.1.1.2.2.2. Measurement instrument.

The voltmeter used in this test shall measure DC values and has an internal resistance of at least 10 MΩ.

8.1.1.2.2.3. Measurement method.

8.1.1.2.2.3.1. First step.

The voltage is measured as shown in Figure 18 and the high voltage bus voltage (V_b) is recorded. V_b shall be equal to or greater than the nominal operating voltage of the REESS and/or energy conversion system as specified by the vehicle manufacturer.

Figure 18
Measurement of V_b , V_1 , V_2

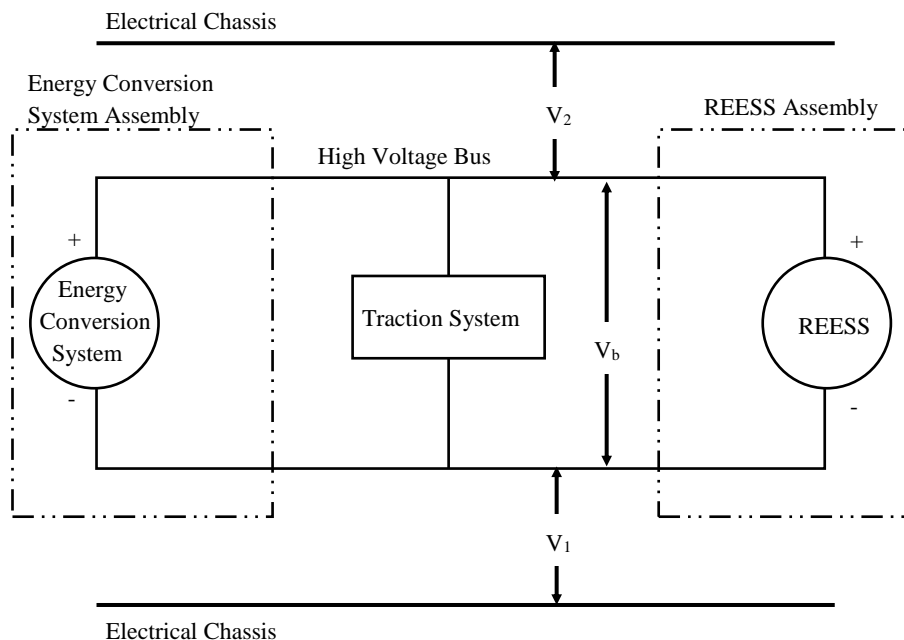

8.1.1.2.2.3.2. Second step.

The voltage (V_1) between the negative side of the high voltage bus and the electrical chassis is measured and recorded (see Figure 18).

8.1.1.2.2.3.3. Third step.

The voltage (V_2) between the positive side of the high voltage bus and the electrical chassis is measured and recorded (see Figure 18).

8.1.1.2.2.3.4. Fourth step.

If V_1 is greater than or equal to V_2 , a standard known resistance (R_o) is inserted between the negative side of the high voltage bus and the electrical chassis. With R_o installed, the voltage (V_1') between the negative side of the high voltage bus and the electrical chassis is measured (see Figure 19).

The electrical isolation (R_i) is calculated according to the following formula:

$$R_i = R_o \cdot (V_b/V_1' - V_b/V_1) \text{ or } R_i = R_o \cdot V_b \cdot (1/V_1' - 1/V_1)$$

Figure 19

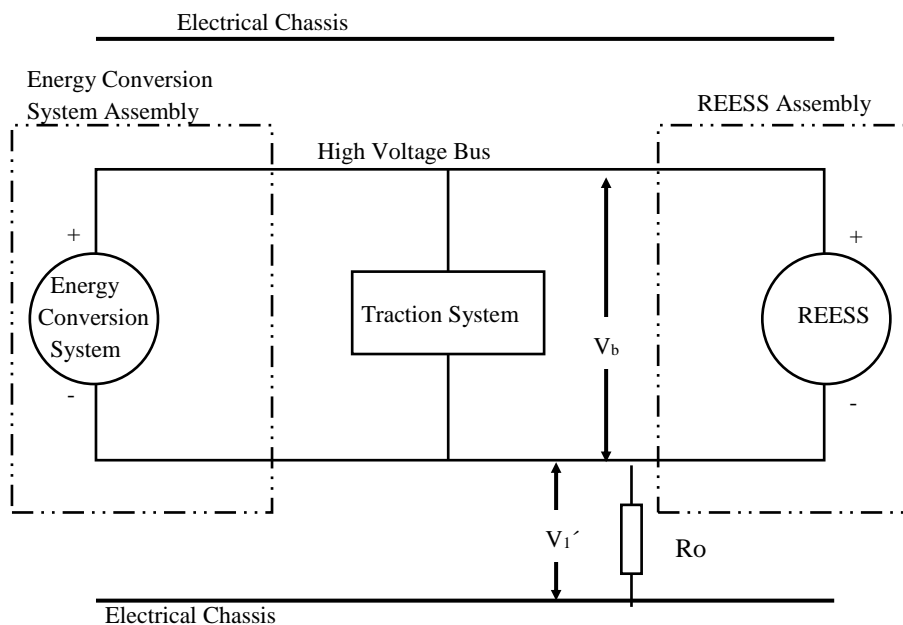
Measurement of V_1' 

If V_2 is greater than V_1 , a standard known resistance (R_o) is inserted between the positive side of the high voltage bus and the electrical chassis. With R_o installed, the voltage (V_2') between the positive side of the high voltage bus and the electrical chassis is measured. (See Figure 20). The electrical isolation (R_i) is calculated according to the formula shown below. This electrical isolation value (in Ω) is divided by the nominal operating voltage of the high voltage bus (in V). The electrical isolation (R_i) is calculated according to the following formula:

$$R_i = R_o \cdot (V_b/V_2' - V_b/V_2) \text{ or } R_i = R_o \cdot V_b \cdot (1/V_2' - 1/V_2)$$

Figure 20
Measurement of V_2'

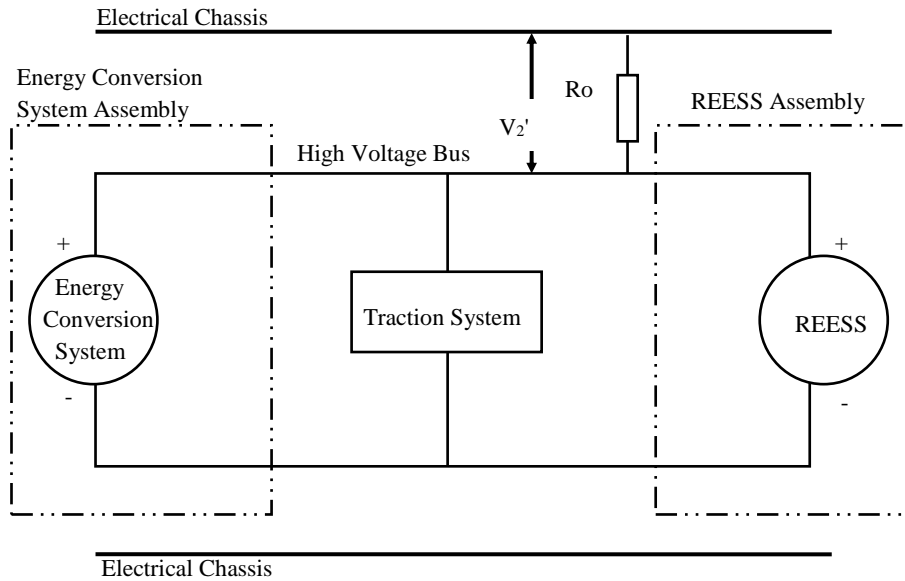

8.1.1.2.2.3.5. Fifth step.

The electrical isolation value R_i (in Ω) divided by the working voltage of the high voltage bus (in V) results in the isolation resistance (in Ω/V).

(Note 1: The standard known resistance R_o (in Ω) is the value of the minimum required isolation resistance (in Ω/V) multiplied by the working voltage of the vehicle plus/minus 20 per cent (in V). R_o is not required to be precisely this value since the equations are valid for any R_o ; however, a R_o value in this range should provide good resolution for the voltage measurements.)

8.1.2. Confirmation method for functions of on-board isolation resistance monitoring system.

The on-board isolation resistance monitoring system specified in paragraph 7.1.1.2.4.3. for fuel cell vehicles and that specified in paragraph 7.1.1.3.4. for protection against water effects shall be tested using the following procedure:

- (a) Determine the isolation resistance, R_i , of the electric power train with the electrical isolation monitoring system using the procedure outlined paragraph 8.1.1.;
- (b) If the minimum isolation resistance value required in accordance with paragraphs 7.1.1.2.4.1. or 7.1.1.2.4.2. is $100 \Omega/V$, insert a resistor with resistance R_o between the positive terminal of the electric power train and the electrical chassis. The magnitude of the resistor, R_o , shall be such that:

$$1/(1/(95xV) - 1/R_i) \leq R_o < 1/(1/(100xV) - 1/R_i)$$

where V is the working voltage of the electric power train.

- (c) If the minimum isolation resistance value required in accordance with paragraphs 7.1.1.2.4.1. or 7.1.1.2.4.2. is $500 \Omega/V$, insert a resistor with resistance R_o between the positive terminal of the electric power train

and the electrical chassis. The magnitude of the resistor, R_o , shall be such that:

$$1/(1/(475 \times V) - 1/R_i) \leq R_o < 1/(1/(500 \times V) - 1/R_i)$$

where V is the working voltage of the electric power train.

8.1.3. Protection against direct contact to live parts.

8.1.3.1. Access probes.

Access probes to verify the protection of persons against access to live parts are given in Table 5.

8.1.3.2. Test conditions.

The access probe is pushed against any openings of the enclosure with the force specified in Table 5. If it partly or fully penetrates, it is placed in every possible position, but in no case shall the stop face fully penetrate through the opening.

Internal electrical protection barriers are considered part of the enclosure.

A low-voltage supply (of not less than 40 V and not more than 50 V) in series with a suitable lamp is connected, if necessary, between the probe and live parts inside the electrical protection barrier or enclosure.

The signal-circuit method is also applied to the moving live parts of high voltage equipment.

Internal moving parts may be operated slowly, where this is possible.

8.1.3.3. Acceptance conditions.

The access probe shall not touch live parts.

If this requirement is verified by a signal circuit between the probe and live parts, the lamp shall not light.

In the case of the test for protection IPXXB, the jointed test finger may penetrate to its 80 mm length, but the stop face (diameter 50 mm x 20 mm) shall not pass through the opening. Starting from the straight position, both joints of the test finger are successively bent through an angle of up to 90 ° with respect to the axis of the adjoining section of the finger and are placed in every possible position.

In case of the tests for protection IPXXD, the access probe may penetrate to its full length, but the stop face shall not fully penetrate through the opening.

Table 5
Access probes for the tests for protection of persons against access to hazardous parts

First numeral	Addit. letter	Access probe (Dimensions in mm)	Test force
2	B	<p style="text-align: center;">Jointed test finger</p> 	10 N±10%
4, 5, 6	D	<p style="text-align: center;">Test wire 1.0 mm diameter, 100 mm long</p> 	1N±10%

Figure 22
Jointed Test Finger



Material: metal, except where otherwise specified.

Linear dimensions in mm.

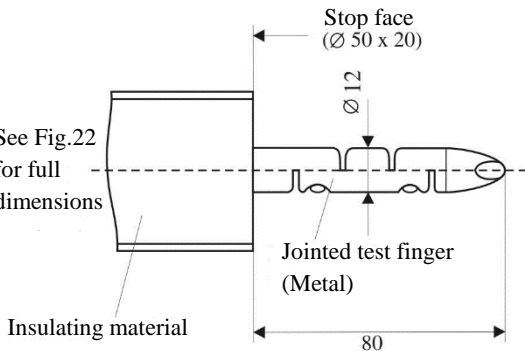
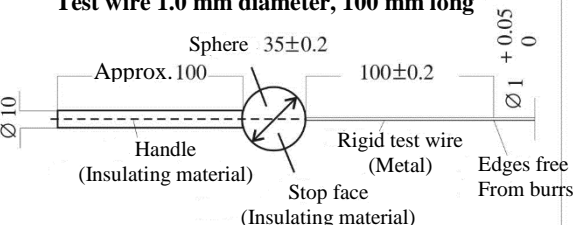
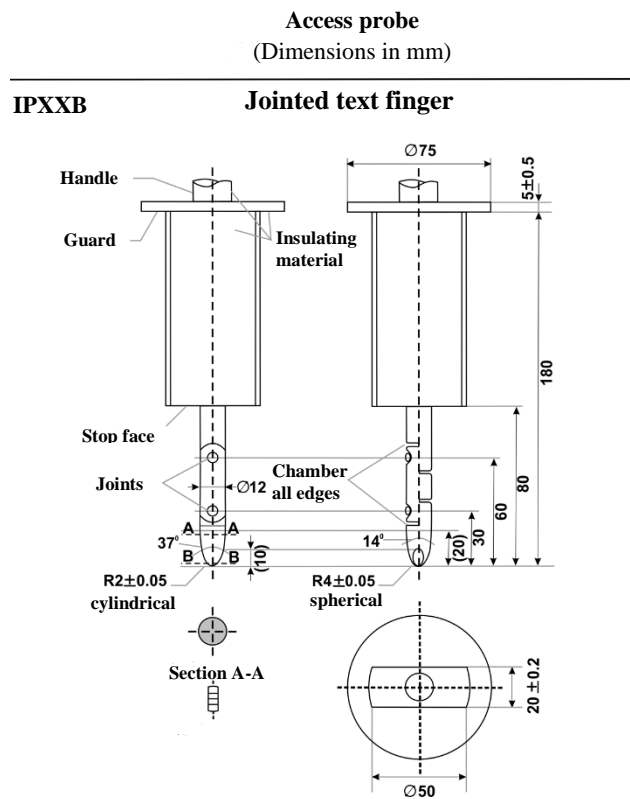
Tolerances on dimensions without specific tolerance:

- (a) on angles: 0/10 seconds;
- (b) on linear dimensions:
 - (i) up to 25 mm: 0/-0.05;
 - (ii) over 25 mm: ± 0.2 .

Both joints shall permit movement in the same plane and the same direction through an angle of 90° with a 0 to $+10^\circ$ tolerance.

8.1.4. Test method for measuring electric resistance:

- (a) Test method using a resistance tester.

The resistance tester is connected to the measuring points (typically, electrical chassis and electro conductive enclosure/electrical protection barrier) and the resistance is measured using a resistance tester that meets the specification that follows:

- (i) Resistance tester: Measurement current at least 0.2 A;
- (ii) Resolution: 0.01 Ω or less;

- (iii) The resistance R shall be less than 0.1Ω.
- (b) Test method using DC power supply, voltmeter and ammeter.

Example of the test method using DC power supply, voltmeter and ammeter is shown below.

Figure 23

Example of test method using DC power supply

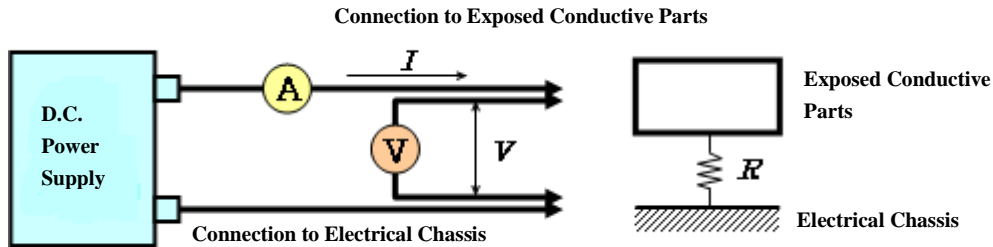

8.1.4.1. Test Procedure.

The DC power supply, voltmeter and ammeter are connected to the measuring points (Typically, electrical chassis and electro conductive enclosure/electrical protection barrier).

The voltage of the DC power supply is adjusted so that the current flow becomes at least 0.2 A.

The current "I" and the voltage "V" are measured.

The resistance "R" is calculated according to the following formula:

$$R = V / I$$

The resistance R shall be less than 0.1 Ω.

Note:

If lead wires are used for voltage and current measurement, each lead wire shall be independently connected to the electrical protection barrier/enclosure/electrical chassis. Terminal can be common for voltage measurement and current measurement.

8.1.5. Test procedure for Protection against water effects.

8.1.5.1. Washing.

This test is intended to simulate the normal washing of vehicles, but not specific cleaning using high water pressure or underbody washing.

The areas of the vehicle regarding this test are border lines, i.e. a seal of two parts such as flaps, glass seals, outline of opening parts, outline of front grille and seals of lamps.

All border lines shall be exposed and followed in all directions with the water stream using a hose nozzle and conditions in accordance with IPX5 as specified in Annex 2.

8.1.5.2. Driving through standing water.

The vehicle shall be driven in a wade pool, with 10 cm water depth, over a distance of 500 m at a speed of 20 km/h, in a time of approximately 1.5 min.

If the wade pool used is less than 500 m in length, then the vehicle shall be driven through it several times. The total time, including the periods outside the wade pool, shall be less than 10 min.

8.2. Test procedures for REESS.

8.2.1. General procedures.

8.2.1.1. Procedure for conducting a standard cycle.

Procedure for conducting a standard cycle for a complete REESS, REESS subsystem(s), or complete vehicle.

A standard cycle shall start with a standard discharge and is followed by a standard charge. The standard cycle shall be conducted at an ambient temperature of 20 ± 10 °C.

Standard discharge:

Discharge rate: The discharge procedure including termination criteria shall be defined by the manufacturer. If not specified, then it shall be a discharge with 1C current for a complete REESS and REESS subsystems.

Discharge limit (end voltage): Specified by the manufacturer.

For a complete vehicle, discharge procedure using a dynamometer shall be defined by the manufacturer. Discharge termination will be according to vehicle controls.

Rest period after discharge: minimum 15 min.

Standard charge:

The charge procedure shall be defined by the manufacturer. If not specified, then it shall be a charge with C/3 current. Charging is continued until normally terminated. Charge termination shall be according to paragraph 8.2.1.2.2 for REESS or REESS subsystem.

For a complete vehicle that can be charged by an external source, charge procedure using an external electric power supply shall be defined by the manufacturer. For a complete vehicle that can be charged by on-board energy sources, a charge procedure using a dynamometer shall be defined by the manufacturer. Charge termination will be according to vehicle controls.

8.2.1.2. Procedures for SOC adjustment.

8.2.1.2.1. The adjustment of SOC shall be conducted at an ambient temperature of 20 ± 10 °C for vehicle-based tests and 22 ± 5 °C for component-based tests.

8.2.1.2.2. The SOC of the tested-device shall be adjusted according to one of the following procedures as applicable. Where different charging procedures are possible, the REESS shall be charged using the procedure which yields the highest SOC:

- (a) For a vehicle with a REESS designed to be externally charged, the REESS shall be charged to the highest SOC in accordance with the procedure specified by the manufacturer for normal operation until the charging process is normally terminated;
- (b) For a vehicle with a REESS designed to be charged only by an energy source on the vehicle, the REESS shall be charged to the highest SOC which is achievable with normal operation of the vehicle. The

manufacturer shall advise on the vehicle operation mode to achieve this SOC;

- (c) In case that the REESS or REESS sub-system is used as the Tested-Device, the Tested-Device shall be charged to the highest SOC in accordance with the procedure specified by the manufacturer for normal use operation until the charging process is normally terminated. Procedures specified by the manufacturer for manufacturing, service or maintenance may be considered as appropriate if they achieve an equivalent SOC as for that under normal operating conditions. In case the Tested-Device does not control SOC by itself, the SOC shall be charged to not less than 95 per cent of the maximum normal operating SOC defined by the manufacturer for the specific configuration of the Tested-Device.

8.2.1.2.3. When the vehicle or REESS subsystem is tested, the SOC shall be no less than 95 per cent of the SOC according to paragraphs 8.2.1.2.1. and 8.2.1.2.2. for REESS designed to be externally charged and shall be no less than 90 per cent of SOC according to paragraphs 8.2.1.2.1. and 8.2.1.2.2. for REESS designed to be charged only by an energy source on the vehicle. The SOC will be confirmed by a method provided by the manufacturer.

8.2.2. Vibration test.

8.2.2.1. Purpose.

The purpose of this test is to verify the safety performance of the REESS under a vibration environment which the REESS will likely experience during the normal operation of the vehicle.

8.2.2.2. Installations.

8.2.2.2.1. This test shall be conducted either with the complete REESS or with REESS subsystem(s). If the manufacturer chooses to test with subsystem(s), the manufacturer shall demonstrate that the test result can reasonably represent the performance of the complete REESS with respect to its safety performance under the same conditions. If the electronic management control unit for the REESS is not integrated in the casing enclosing the cells, then the electronic management unit may be omitted from installation on the Tested-Device if so requested by the manufacturer.

8.2.2.2.2. The Tested-Device shall be firmly secured to the platform of the vibration machine in such a manner as to ensure that the vibrations are directly transmitted to the Tested Device.

As an alternative, the Test-Device should be mounted with its original mounting points and holders as mounted in the vehicle. The holders should be firmly secured to the platform of the vibration machine in such a manner as to ensure that the vibrations are directly transmitted to the holders of the Tested-Device.

8.2.2.3. Procedures.

8.2.2.3.1. General test conditions.

The following conditions shall apply to the Tested-Device:

- (a) The test shall be conducted at an ambient temperature of 22 ± 5 °C;

- (b) At the beginning of the test, the SOC shall be adjusted in accordance with the paragraph 8.2.1.2.;
- (c) At the beginning of the test, all protection devices which affect the function(s) of the Tested-Device that are relevant to the outcome of the test shall be operational.

8.2.2.3.2. Test procedures.

The Tested-Device shall be subjected to a vibration having a sinusoidal waveform with a logarithmic sweep between 7 Hz and 50 Hz and back to 7 Hz traversed in 15 minutes. This cycle shall be repeated 12 times for a total of 3 hours in the vertical direction of the mounting orientation of the REESS as specified by the manufacturer.

The correlation between frequency and acceleration shall be as shown in Table 6.

Table 6
Frequency and acceleration

<i>Frequency (Hz)</i>	<i>Acceleration (m/s²)</i>
7-18	10
18 - 30	gradually reduced from 10 to 2
30 - 50	2

At the request of the manufacturer, a higher acceleration level as well as a higher maximum frequency may be used.

At the choice of the manufacturer, a vibration test profile determined by the vehicle-manufacturer verified for the vehicle application may be used as a substitute for the frequency - acceleration correlation of Table 6. The REESS certified according to this condition shall be limited to the installation for a specific vehicle type.

After the vibration profile, a standard cycle as described in paragraph 8.2.1.1. shall be conducted, if not inhibited by the Tested-Device.

The test shall end with an observation period of 1 hour at the ambient temperature conditions of the test environment.

8.2.3. Thermal shock and cycling test.

8.2.3.1. Purpose.

The purpose of this test is to verify the resistance of the REESS to sudden changes in temperature. The REESS shall undergo a specified number of temperature cycles, which start at ambient temperature followed by high and low temperature cycling. It simulates a rapid environmental temperature change which a REESS would likely experience during its life.

8.2.3.2. Installations.

This test shall be conducted either with the complete REESS or with REESS subsystem(s). If the manufacturer chooses to test with subsystem(s), the manufacturer shall demonstrate that the test result can reasonably represent the performance of the complete REESS with respect to its safety

performance under the same conditions. If the electronic management unit for the REESS is not integrated in the casing enclosing the cells, then the electronic management unit may be omitted from installation on the Tested-Device if so requested by the manufacturer.

8.2.3.3. Procedures.

8.2.3.3.1. General test conditions.

The following conditions shall apply to the Tested-Device at the start of the test:

- (a) The SOC shall be adjusted in accordance with the paragraph 8.2.1.2.;
- (b) All protection devices, which would affect the function of the Tested-Device and which are relevant to the outcome of the test shall be operational;

8.2.3.3.2. Test procedure.

The Tested-Device shall be stored for at least 6 hours at a test temperature equal to 60 ± 2 °C or higher if requested by the manufacturer, followed by storage for at least 6 hours at a test temperature equal to -40 ± 2 °C or lower if requested by the manufacturer. The maximum time interval between test temperature extremes shall be 30 minutes. This procedure shall be repeated until a minimum of 5 total cycles are completed, after which the Tested-Device shall be stored for 24 hours at an ambient temperature of 22 ± 5 °C.

After the storage for 24 hours, a standard cycle as described in paragraph 8.2.1.1. shall be conducted, if not inhibited by the Tested-Device.

The test shall end with an observation 1 hour at the ambient temperature conditions of the test environment.

8.2.4. Fire resistance test.

8.2.4.1. Purpose.

The purpose of this test is to verify the resistance of the REESS, against exposure to fire from outside of the vehicle due to e.g. a fuel spill from a vehicle (either the vehicle itself or a nearby vehicle). This situation should leave the driver and passengers with enough time to evacuate.

8.2.4.2. Installations.

8.2.4.2.1. This test shall be conducted either with the complete REESS or with REESS subsystem(s). If the manufacturer chooses to test with subsystem(s), the manufacturer shall demonstrate that the test result can reasonably represent the performance of the complete REESS with respect to its safety performance under the same conditions. If the electronic management unit for the REESS is not integrated in the casing enclosing the cells, then the electronic management unit may be omitted from installation on the Tested-Device if so requested by the manufacturer. Where the relevant REESS subsystems are distributed throughout the vehicle, the test may be conducted on each relevant REESS subsystem.

8.2.4.3. Procedures.

8.2.4.3.1. General test conditions.

The following requirements and conditions shall apply to the test:

- (a) The test shall be conducted at a temperature of at least 0°C;
- (b) At the beginning of the test, the SOC shall be adjusted in accordance with the paragraph 8.2.1.2.;
- (c) At the beginning of the test, all protection devices which affect the function of the Tested-Device and are relevant for the outcome of the test shall be operational.

8.2.4.3.2. Test procedure.

A vehicle based test or a component based test shall be performed at the discretion of the manufacturer.

8.2.4.3.2.1. Vehicle based test (according to test procedure described in paragraph 8.2.4.3.3.).

The Tested-Device shall be mounted in a testing fixture simulating actual mounting conditions as far as possible; no combustible material should be used for this with the exception of material that is part of the REESS. The method whereby the Tested-Device is fixed in the fixture shall correspond to the relevant specifications for its installation in a vehicle. In the case of a REESS designed for a specific vehicle use, vehicle parts which affect the course of the fire in any way shall be taken into consideration.

8.2.4.3.2.2. Component based test (according to test procedure described in paragraph 8.2.4.3.3. (Gasoline pool fire) or paragraph 8.2.4.3.4. (LPG burner))

In case of component based test, the manufacturer may choose either Gasoline pool fire test or LPG burner test.

8.2.4.3.3. Gasoline pool fire test set up for both vehicle-based and component-based test.

The Tested-Device shall be placed on a grating table positioned above the fire source, in an orientation according to the manufacturer's design intent.

The grating table shall be constructed by steel rods, diameter 6-10 mm, with 4-6 cm in between. If needed the steel rods could be supported by flat steel parts.

The flame to which the Tested-Device is exposed shall be obtained by burning commercial fuel for positive-ignition engines (hereafter called "fuel") in a pan. The quantity of fuel shall be sufficient to permit the flame, under free-burning conditions, to burn for the whole test procedure.

The fire shall cover the whole area of the pan during whole fire exposure. The pan dimensions shall be chosen so as to ensure that the sides of the Tested-Device are exposed to the flame. The pan shall therefore exceed the horizontal projection of the Tested-Device by at least 20 cm, but not more than 50 cm. The sidewalls of the pan shall not project more than 8 cm above the level of the fuel at the start of the test.

8.2.4.3.3.1. The pan filled with fuel shall be placed under the Tested-Device in such a way that the distance between the level of the fuel in the pan and the bottom of the Tested-Device corresponds to the design height of the Tested-Device above the road surface at the unladed mass if paragraph 8.2.4.3.2.1. is applied or approximately 50 cm if paragraph 8.2.4.3.2.2. is applied. Either the pan, or the testing fixture, or both, shall be freely movable.

- 8.2.4.3.3.2. During phase C of the test, the pan shall be covered by a screen. The screen shall be placed 3 cm +/- 1 cm above the fuel level measured prior to the ignition of the fuel. The screen shall be made of a refractory material, as prescribed in Figure 28. There shall be no gap between the bricks and they shall be supported over the fuel pan in such a manner that the holes in the pan are not obstructed. The length and width of the frame shall be 2 cm to 4 cm smaller than the interior dimensions of the pan so that a gap of 1 cm to 2 cm exists between the frame and the wall of the pan to allow ventilation. Before the test, the screen shall be at least at the ambient temperature. The firebricks may be wetted in order to guarantee repeatable test conditions.
- 8.2.4.3.3.3. If the tests are carried out in the open air, sufficient wind protection shall be provided and the wind velocity at pan level shall not exceed 2.5 km/h.
- 8.2.4.3.3.4. The test shall comprise of three phases B-D, if the fuel is at a temperature of at least 20 °C. Otherwise, the test shall comprise four phases A-D.
- 8.2.4.3.3.4.1. Phase A: Pre-heating (Figure 24).

The fuel in the pan shall be ignited at a distance of at least 3 m from the Tested-Device. After 60 seconds pre-heating, the pan shall be placed under the Tested-Device. If the size of the pan is too large to be moved without risking liquid spills etc. then the Tested-Device and test rig can be moved over the pan instead.

Figure 24
Phase A: Pre-heating

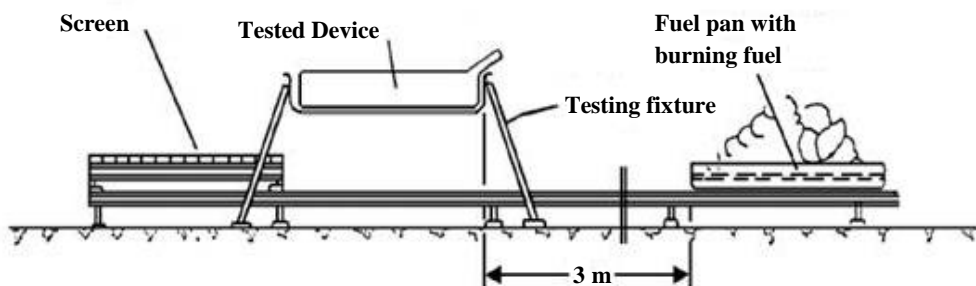

- 8.2.4.3.3.4.2. Phase B: Direct exposure to flame (Figure 25).

The Tested-Device shall be exposed to the flame from the freely burning fuel for 70 seconds.

Figure 25
Phase B: Direct exposure to flame

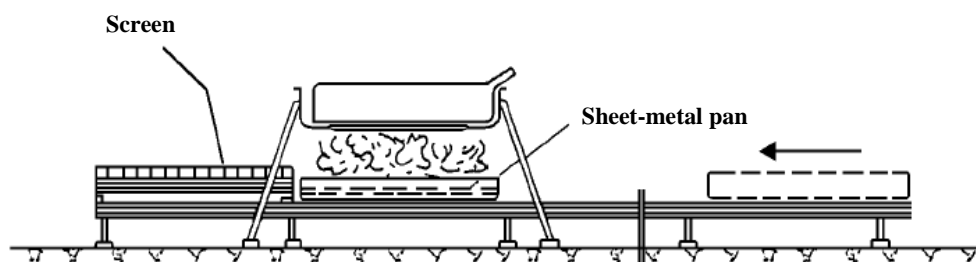

8.2.4.3.3.4.3. Phase C: Indirect exposure to flame (Figure 26).

As soon as phase B has been completed, the screen shall be placed between the burning pan and the Tested-Device. The Tested-Device shall be exposed to this reduced flame for a further 60 seconds.

As a compliance alternative to conducting Phase C of the test, Phase B may, at the choice of the manufacturer, be continued for an additional 60 seconds.

Figure 26

Phase C: Indirect exposure to flame

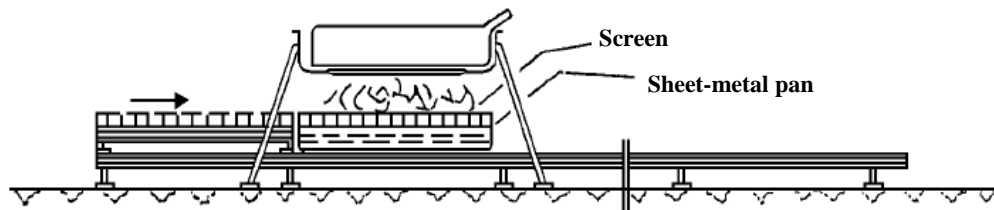

8.2.4.3.3.4.4. Phase D: End of test (Figure 27).

The burning pan covered with the screen shall be moved back to the position described in phase A. No extinguishing of the Tested-Device shall be done. After removal of the pan the Tested-Device shall be observed until such time as the surface temperature of the Tested-Device has decreased to ambient temperature or has been decreasing for a minimum of 3 hours.

Figure 27

Phase D: End of test

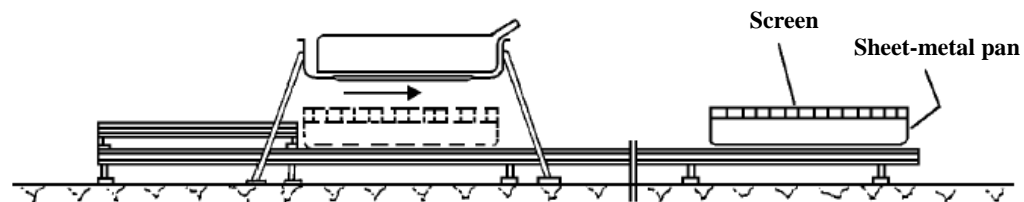
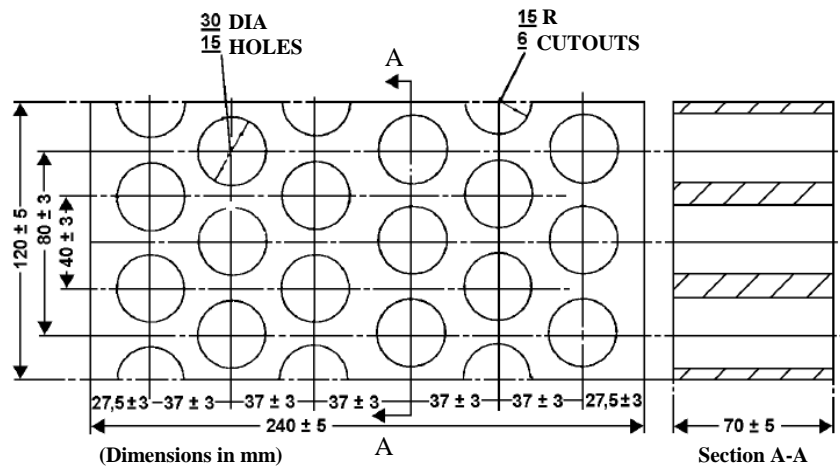

Figure 28

Dimension of Firebricks



Fire resistance	(Seger-Kegel) SK 30
Al ₂ O ₃ content	30 - 33 per cent
Open porosity (Po)	20 - 22 per cent vol.
Density	1,900 - 2,000 kg/m ³
Effective holed area	44.18 per cent

- 8.2.4.3.4. LPG burner fire test set up for component based test.
- 8.2.4.3.4.1. The Tested-Device shall be placed on a test equipment, in the position that the manufacturer's design intends.
- 8.2.4.3.4.2. LPG burner shall be used to produce flame to which the tested-device is exposed. The height of the flame shall be about 60 cm or more, without the Tested-Device.
- 8.2.4.3.4.3. The flame temperature shall be measured continuously by temperature sensors. An average temperature shall be calculated, at least every second for the duration of the whole fire exposure, as the arithmetic average of temperatures measured by all temperature sensors fulfilling the location requirements described in paragraph 8.2.4.3.4.4.
- 8.2.4.3.4.4. All temperature sensors shall be installed at a height of 5 ± 1 cm below the lowest point of the Tested-Device's external surface when oriented as described in paragraph 8.2.4.3.4.1. At least one temperature sensor shall be located at the centre of Tested-Device, and at least four temperature sensors shall be located within 10 cm from the edge of the Tested-Device towards its centre with nearly equal distance between the sensors.
- 8.2.4.3.4.5. The bottom of Tested-Device shall be exposed to the even flame directly and entirely by fuel combustion. LPG burner flame shall exceed the horizontal projection of the tested-device by at least 20 cm.
- 8.2.4.3.4.6. The Tested-Device shall be exposed to flame for 2 minutes after the averaged temperature reaches 800 °C within 30 seconds. The averaged temperature shall be maintained 800-1,100 °C for 2 minutes.
- 8.2.4.3.4.7. After direct exposure to flame the Tested-Device shall be observed until such time as the surface temperature of the Tested-Device has decreased to ambient temperature or has been decreasing for a minimum of 3 hours.
- 8.2.5. External short circuit protection.
- 8.2.5.1. Purpose.
- The purpose of this test is to verify the performance of the short circuit protection to prevent the REESS from any further related severe events caused by short circuit current.
- 8.2.5.2. Installations.
- This test shall be conducted either with a complete vehicle or with the complete REESS or with the REESS subsystem(s). If the REESS consists of multiple REESS subsystems, either connected in series or in parallel, the test can be performed on a single REESS subsystem which includes an electronic management unit and (if it exists) a REESS protection device intended to be operational. If the manufacturer chooses to test with REESS subsystem(s), the manufacturer shall demonstrate that the test result can reasonably represent the performance of the complete REESS with respect to its safety

performance under the same conditions. If the electronic management unit for the REESS is not integrated in the casing enclosing the cells, then the electronic management unit may be omitted from installation on the Tested-Device at the request of the manufacturer.

For a test with a complete vehicle, the manufacturer may provide information to connect a breakout harness to a location just outside the REESS that would permit applying a short circuit to the REESS.

8.2.5.3. Procedures.

8.2.5.3.1. General test conditions.

The following condition shall apply to the test:

- (a) The test shall be conducted at a ambient temperature of 20 ± 10 °C or at higher temperature if requested by the manufacturer;
- (b) At the beginning of the test, the SOC shall be adjusted in accordance with the paragraph 8.2.1.2.;
- (c) For testing with a complete REESS or REESS subsystem(s), at the beginning of the test, all protection devices which would affect the function of the Tested-Device and which are relevant to the outcome of the test shall be operational;
- (d) For testing with a complete vehicle, a breakout harness is connected to the manufacturer specified location and vehicle protections systems relevant to the outcome of the test shall be operational.

8.2.5.3.2. Short circuit

At the start of the test all, relevant main contactors for charging and discharging shall be closed to represent the active driving possible mode as well as the mode to enable external charging. If this cannot be completed in a single test, then two or more tests shall be conducted.

For testing with a complete REESS or REESS subsystem(s), the positive and negative terminals of the Tested-Device shall be connected to each other to produce a short circuit. The connection used for creating the short circuit (including the cabling) shall have a resistance not exceeding 5 mΩ.

For testing with a complete vehicle, the short circuit is applied through the breakout harness. The connection used for creating the short circuit (including the cabling) shall have a resistance not exceeding 5 mΩ.

The short circuit condition shall be continued until the protection function operation of the REESS terminates the short circuit current, or for at least 1 h after the temperature measured on the casing of the Tested-Device or the REESS has stabilized, such that the temperature gradient varies by less than 4°C through 2 hours.

8.2.5.3.3. Standard Cycle and observation period

Directly after the termination of the short circuit a standard cycle as described in paragraph 8.2.1.1 shall be conducted, if not inhibited by the Tested-Device.

The test shall end with an observation period of 1 hour at the ambient temperature conditions of the test environment.

8.2.6. Overcharge protection test.

8.2.6.1. Purpose.

The purpose of this test is to verify the performance of the overcharge protection to prevent the REESS from any further related severe events caused by a too high SOC.

8.2.6.2. Installations.

This test shall be conducted, under standard operating conditions, either with a complete vehicle or with the complete REESS. Ancillary systems that do not influence to the test results may be omitted from the Tested-Device.

The test may be performed with a modified Tested-Device provided these modifications shall not influence the test results.

8.2.6.3. Procedures.

8.2.6.3.1. General test conditions.

The following requirements and conditions shall apply to the test:

- (a) The test shall be conducted at an ambient temperature of 20 ± 10 °C or at a higher temperature if requested by the manufacturer;
- (b) The SOC of REESS shall be adjusted around the middle of normal operating range by normal operation recommended by the manufacturer such as driving the vehicle or using an external charger. The accurate adjustment is not required as long as the normal operation of the REESS is enabled;
- (c) For vehicle-based test of vehicles with on-board energy conversion systems (e.g. internal combustion engine, fuel cell, etc.), fill the fuel to allow the operation of such energy conversion systems;
- (d) At the beginning of the test, all protection devices which would affect the function of the Tested-Device and which are relevant to the outcome of the test shall be operational. All relevant main contactors for charging shall be closed.

8.2.6.3.2. Charging.

The procedure for charging the REESS for vehicle-based test shall be in accordance with paragraphs 8.2.6.3.2.1. and 8.2.6.3.2.2. and shall be selected as appropriate for the relevant mode of vehicle operation and the functionality of the protection system. Alternatively, the procedure for charging the REESS for vehicle-based test shall be in accordance with paragraph 8.2.6.3.2.3. For component-based test, the charging procedure shall be in accordance with paragraph 8.2.6.3.2.4.

8.2.6.3.2.1. Charge by vehicle operation.

This procedure is applicable to the vehicle-based tests in active driving possible mode:

- (a) For vehicles that can be charged by on-board energy sources (e.g. energy recuperation, on-board energy conversion systems), the vehicle shall be driven on a chassis dynamometer. The vehicle operation on a chassis dynamometer (e.g. simulation of continuous down-hill driving) that will deliver as high charging current as reasonably

achievable shall be determined, if necessary, through consultation with the manufacturer;

- (b) The REESS shall be charged by the vehicle operation on a chassis dynamometer in accordance with paragraph 8.2.6.3.2.1.(a). The vehicle operation on the chassis dynamometer shall be terminated when the vehicle's overcharge protection controls terminates the REESS charge current or the temperature of the REESS is stabilised such that the temperature varies by a gradient of less than 2 °C through 1 hour. Where an automatic interrupt function vehicle's overcharge protection control fails to operate, or if there is no such control function, the charging shall be continued until the REESS temperature reaches 10 °C above its maximum operating temperature specified by the manufacturer;
- (c) Immediately after the termination of charging, one standard cycle as described in paragraph 8.2.1.1. shall be conducted, if it is not prohibited by the vehicle, with vehicle operation on a chassis dynamometer.

8.2.6.3.2.2. Charge by external electricity supply (vehicle-based test).

This procedure is applicable to vehicle-based test for externally chargeable vehicles:

- (a) The vehicle inlet for normal use, if it exists, shall be used for connecting the external electricity supply equipment. The charge control communication of the external electricity supply equipment shall be altered or disabled to allow the charging specified in paragraph 8.2.6.3.2.2.(b) below;
- (b) The REESS shall be charged by the external electricity supply equipment with the maximum charge current specified by the manufacturer. The charging shall be terminated when the vehicle's overcharge protection control terminates the REESS charge current. Where vehicle's overcharge protection control fails to operate, or if there is no such control, the charging shall be continued until the REESS temperature reaches 10 °C above its maximum operating temperature specified by the manufacturer. In the case where charge current is not terminated and where the REESS temperature remains less than 10 °C above the maximum operating temperature, vehicle operation shall be terminated 12 hours after the start of charging by external electricity supply equipment;
- (c) Immediately after the termination of charging, one standard cycle as described in paragraph 8.2.1.1. shall be conducted, if it is not prohibited by the vehicle, with vehicle operation on a chassis dynamometer for discharging and with external electricity supply equipment for charging.

8.2.6.3.2.3. Charge by connecting breakout harness (vehicle-based test).

This procedure is applicable to vehicle-based tests for both externally chargeable vehicles and vehicles that can be charged only by on-board energy sources and for which the manufacturer provides information to connect a breakout harness to a location just outside the REESS that permits charging of the REESS:

- (a) The breakout harness is connected to the vehicle as specified by the manufacturer. The trip current/voltage setting of the external charge-discharge equipment shall be at least 10 per cent higher than the current/voltage limit of the Tested-Device. The external electricity supply equipment is connected to the breakout harness. The REESS shall be charged by the external electricity power supply with the maximum charge current specified by the manufacturer;
- (b) The charging shall be terminated when the vehicle's overcharge protection control terminates the REESS charge current. Where vehicle's overcharge protection control fails to operate, or if there is no such control, the charging shall be continued until the REESS temperature is 10 °C above its maximum operating temperature specified by the manufacturer. In the case where charge current is not terminated and where the REESS temperature remains less than 10 °C above the maximum operating temperature, vehicle operation shall be terminated 12 hours after the start of charging by external electricity supply equipment;
- (c) Immediately after the termination of charging, one standard cycle as described in paragraph 8.2.1.1. (for a complete vehicle) shall be conducted, if it is not prohibited by the vehicle.

8.2.6.3.2.4. Charge by external electricity supply (component-based test).

This procedure is applicable to component-based test:

- (a) The external charge/discharge equipment shall be connected to the main terminals of the REESS. The charge control limits of the test equipment shall be disabled;
- (b) The REESS shall be charged by the external charge/discharge equipment with the maximum charge current specified by the manufacturer. The charging shall be terminated when the REESS overcharge protection control terminates the REESS charge current. Where overcharge protection control of the REESS fails to operate, or if there is no such control, the charging shall be continued until the REESS temperature reaches 10 °C above its maximum operating temperature specified by the manufacturer. In the case where charge current is not terminated and where the REESS temperature remains less than 10 °C above the maximum operating temperature, vehicle operation shall be terminated 12 hours after the start of charging by external electricity supply equipment;
- (c) Immediately after the termination of charging, one standard cycle as described in paragraph 8.2.1.1. shall be conducted, if it is not prohibited by the REESS, with external charge-discharge equipment.

8.2.6.4. The test shall end with an observation period of 1 hour at the ambient temperature conditions of the test environment.

8.2.7. Over-discharge protection test.

8.2.7.1. Purpose.

The purpose of this test is to verify the performance of the over-discharge protection to prevent the REESS from any severe events caused by a too low SOC.

8.2.7.2. Installations.

This test shall be conducted, under standard operating conditions, either with a complete vehicle or with the complete REESS. Ancillary systems that do not influence the test results may be omitted from the tested-device.

The test may be performed with a modified Tested-Device provided these modifications shall not influence the test results.

8.2.7.3. Procedures.

8.2.7.3.1. General test conditions.

The following requirements and condition shall apply to the test:

- (a) The test shall be conducted at an ambient temperature of 20 ± 10 °C, or at higher temperature if requested by the manufacturer;
- (b) The SOC of REESS shall be adjusted at the low level, but within normal operating range, by normal operation recommended by the manufacturer, such as driving the vehicle or using an external charger. The accurate adjustment is not required as long as the normal operation of the REESS is enabled;
- (c) For vehicle-based test of vehicles with on-board energy conversion systems (e.g. internal combustion engine, fuel cell, etc.), adjust the fuel level to nearly empty but enough so that the vehicle can enter into active driving possible mode;
- (d) At the beginning of the test, all protection devices which would affect the function of the Tested-Device and which are relevant for the outcome of the test shall be operational.

8.2.7.3.2. Discharging.

The procedure for discharging the REESS for vehicle-based test shall be in accordance with paragraphs 8.2.7.3.2.1. and 8.2.7.3.2.2. Alternatively, the procedure for discharging the REESS for vehicle-based test shall be in accordance with paragraph 8.2.7.3.2.3. For component-based test, the discharging procedure shall be in accordance with paragraph 8.2.7.3.2.4.

8.2.7.3.2.1. Discharge by vehicle driving operation.

This procedure is applicable to the vehicle-based tests in active driving possible mode:

- (a) The vehicle shall be driven on a chassis dynamometer. The vehicle operation on a chassis dynamometer (e.g. simulation of continuous driving at steady speed) that will deliver as constant discharging power as reasonably achievable shall be determined, if necessary, through consultation with the manufacturer;
- (b) The REESS shall be discharged by the vehicle operation on a chassis dynamometer in accordance with paragraph 8.2.7.3.2.1.(a). The vehicle operation on the chassis dynamometer shall be terminated when the vehicle's over-discharge protection control terminates REESS discharge current or the temperature of the REESS is stabilised such that the temperature varies by a gradient of less than 4 °C through 2 hours. Where an over-discharge protection control fails to operate, or if there is no such control, then the discharging shall be

continued until the REESS is discharged to 25 per cent of its nominal voltage level;

- (c) Immediately after the termination of discharging, one standard charge followed by a standard discharge as described in paragraph 8.2.1.1. shall be conducted if it is not prohibited by the vehicle.

8.2.7.3.2.2. Discharge by auxiliary electrical equipment (vehicle-based test).

This procedure is applicable to the vehicle-based tests in stationary condition:

- (a) The vehicle shall be switched in to a stationary operation mode that allow consumption of electrical energy from REESS by auxiliary electrical equipment. Such an operation mode shall be determined, if necessary, through consultation with the manufacturer. Equipments (e.g. wheel chocks) that prevent the vehicle movement may be used as appropriate to ensure the safety during the test;
- (b) The REESS shall be discharged by the operation of electrical equipment, air-conditioning, heating, lighting, audio-visual equipment, etc., that can be switched on under the conditions given in paragraph 8.2.7.3.2.2.(a). The operation shall be terminated when the vehicle's over-discharge protection control terminates REESS discharge current or the temperature of the REESS is stabilised such that the temperature varies by a gradient of less than 4 °C through 2 hours. Where an over-discharge protection control fails to operate, or if there is no such control, then the discharging shall be continued until the REESS is discharged to 25 per cent of its nominal voltage level;
- (c) Immediately after the termination of discharging, one standard charge followed by a standard discharge as described in paragraph 8.2.1.1. shall be conducted if it is not prohibited by the vehicle.

8.2.7.3.2.3. Discharge of REESS using discharge resistor (vehicle-based test).

This procedure is applicable to vehicles for which the manufacturer provides information to connect a breakout harness to a location just outside the REESS that permits discharging the REESS:

- (a) Connect the breakout harness to the vehicle as specified by the manufacturer. Place the vehicle in active driving possible mode;
- (b) A discharge resistor is connected to the breakout harness and the REESS shall be discharged at a discharge rate under normal operating conditions in accordance with manufacturer provided information. A resistor with discharge power of 1 kW may be used;
- (c) The test shall be terminated when the vehicle's over-discharge protection control terminates REESS discharge current or the temperature of the REESS is stabilised such that the temperature varies by a gradient of less than 4 °C through 2 hours. Where an automatic discharge interrupt function fails to operate, or if there is no such function, then the discharging shall be continued until the REESS is discharged to 25 per cent of its nominal voltage level;
- (d) Immediately after the termination of discharging, one standard charge followed by a standard discharge as described in paragraph 8.2.1.1. shall be conducted if it is not prohibited by the vehicle.

8.2.7.3.2.4. Discharge by external equipment (component-based test).

This procedure is applicable to component-based test:

- (a) All relevant main contactors shall be closed. The external charge-discharge shall be connected to the main terminals of the tested-device;
- (b) A discharge shall be performed with a stable current within the normal operating range as specified by the manufacturer;
- (c) The discharging shall be continued until the Tested-Device (automatically) terminates REESS discharge current or the temperature of the Tested-Device is stabilised such that the temperature varies by a gradient of less than 4 °C through 2 hours. Where an automatic interrupt function fails to operate, or if there is no such function, then the discharging shall be continued until the Tested-Device is discharged to 25 per cent of its nominal voltage level;
- (d) Immediately after the termination of the discharging, one standard charge followed by a standard discharge as described in paragraph 8.2.1.1. shall be conducted if not inhibited by the Tested-Device.

8.2.7.4. The test shall end with an observation period of 1 h at the ambient temperature conditions of the test environment.

8.2.8. Over-temperature protection test.

8.2.8.1. Purpose.

The purpose of this test is to verify the performance of the protection measures of the REESS against internal overheating during operation. In the case that no specific protection measures are necessary to prevent the REESS from reaching an unsafe state due to internal over-temperature, this safe operation must be demonstrated.

8.2.8.2. The test may be conducted with a complete REESS according to paragraphs 8.2.8.3. and 8.2.8.4. or with a complete vehicle according to paragraphs 8.2.8.5 and 8.2.8.6.

8.2.8.3. Installation for test conducted using a complete REESS.

8.2.8.3.1. Ancillary systems that do not influence to the test results may be omitted from the tested-device. The test may be performed with a modified Tested-Device provided these modifications shall not influence the test results.

8.2.8.3.2. Where a REESS is fitted with a cooling function and where the REESS will remain functional in delivering its normal power without a cooling function system being operational, the cooling system shall be deactivated for the test.

8.2.8.3.3. The temperature of the Tested-Device shall be continuously measured inside the casing in the proximity of the cells during the test in order to monitor the changes of the temperature. The on-board sensors, if existing, may be used with compatible tools to read the signal.

8.2.8.3.4. The REESS shall be placed in a convective oven or climatic chamber. If necessary, for conduction the test, the REESS shall be connected to the rest of vehicle control system with extended cables. An external charge/discharge equipment may be connected under supervision by the vehicle manufacturer.

8.2.8.4. Test procedures for test conducted using a complete REESS.

- 8.2.8.4.1. At the beginning of the test, all protection devices which affect the function of the Tested-Device and are relevant to the outcome of the test shall be operational, except for any system deactivation implemented in accordance with paragraph 8.2.8.3.2.
- 8.2.8.4.2. The Tested-Device shall be continuously charged and discharged by the external charge/discharge equipment with a current that will increase the temperature of cells as rapidly as possible within the range of normal operation as defined by the manufacturer until the end of the test. Alternatively, the charge and discharge may be conducted by vehicle driving operations on chassis dynamometer where the driving operation shall be determined through consultation with the manufacturer to achieve the conditions above.
- 8.2.8.4.3. The temperature of the chamber or oven shall be gradually increased, from 20 ± 10 °C or at higher temperature if requested by the manufacturer, until it reaches the temperature determined in accordance with paragraph 8.2.8.4.3.1 or paragraph 8.2.8.4.3.2 below as applicable, and then maintained at a temperature that is equal to or higher than this, until the end of the test.
- 8.2.8.4.3.1. Where the REESS is equipped with protective measures against internal overheating, the temperature shall be increased to the temperature defined by the manufacturer as being the operational temperature threshold for such protective measures, to insure that the temperature of the Tested-Device will increase as specified in paragraph 8.2.8.4.2.
- 8.2.8.4.3.2. Where the REESS is not equipped with any specific measures against internal over-heating the temperature shall be increased to the maximum operational temperature specified by the manufacturer.
- 8.2.8.4.4. The test will end when one of the followings is observed:
- (a) The Tested-Device inhibits and/or limits the charge and/or discharge to prevent the temperature increase;
 - (b) The temperature of the Tested-Device is stabilised such that the temperature varies by a gradient of less than 4 °C through 2 hours;
 - (c) Any failure of the acceptance criteria prescribed in paragraph 7.3.8.
- 8.2.8.5. Installation for test conducted using a complete vehicle.
- 8.2.8.5.1. Based on information from the manufacturer, for an REESS fitted with a cooling function the cooling system shall be disabled or in a state of significantly reduced operation (for an REESS that will not operate if the cooling system is disabled) for the test.
- 8.2.8.5.2. The temperature of the REESS shall be continuously measured inside the casing in the proximity of the cells during the test in order to monitor the changes of the temperature using on-board sensors and compatible tools according to manufacturer provided information to read the signals.
- 8.2.8.5.3. For vehicles with on-board energy conversion systems, adjust the fuel level to nearly empty but so that the vehicle can enter into active driving possible mode.
- 8.2.8.5.4. The vehicle shall be placed in in a climate control chamber set to a temperature between 40 °C to 45 °C for at least 6 hours.

- 8.2.8.6. Test procedures for test conducted using a complete vehicle.
- 8.2.8.6.1. The vehicle shall be continuously charged and discharged in a manner that will increase the temperature of REESS cells as rapidly as possible within the range of normal operation as defined by the manufacturer until the end of the test.
- The charge and discharge will be conducted by vehicle driving operations on chassis dynamometer where the driving operation shall be determined through consultation with the manufacturer to achieve the conditions above.
- For a vehicle that can be charged by an external power supply, the charging may be conducted using an external power supply if more rapid temperature increase is expected.
- 8.2.8.6.2. The test will end when one of the followings is observed:
- (a) The vehicle terminates the charge and/or discharge;
 - (b) The temperature of the REESS is stabilised such that the temperature varies by a gradient of less than 4 °C through 2 hours;
 - (c) Any failure of the acceptance criteria prescribed in paragraph 7.3.8.;
 - (d) 3 hours elapse from the time of starting the charge/discharge cycles in paragraph 8.2.8.6.1.
- 8.2.9. Reserved.
- 8.2.10. Mechanical shock test.
- 8.2.10.1. Purpose.
- The purpose of this test is to verify the safety performance of the REESS under inertial loads which may occur during a vehicle crash.
- 8.2.10.2. Installations.
- 8.2.10.2.1. This test shall be conducted either with the complete REESS or with REESS subsystem(s). If the manufacturer chooses to test with REESS subsystem(s), the manufacturer shall demonstrate that the test result can reasonably represent the performance of the complete REESS with respect to its safety performance under the same conditions. If the electronic management unit for the REESS is not integrated in the casing enclosing the cells, then the electronic management unit may be omitted from installation on the Tested-Device if so requested by the manufacturer.
- 8.2.10.2.2. The Tested-Device shall be connected to the test fixture only by the intended mountings provided for the purpose of attaching the REESS or REESS subsystem to the vehicle.
- 8.2.10.3. Procedures.
- 8.2.10.3.1. General test conditions and requirements.
- The following condition shall apply to the test:
- (a) The test shall be conducted at an ambient temperature of 20 ± 10 °C;
 - (b) At the beginning of the test, the SOC shall be adjusted in accordance with the paragraph 8.2.1.2.;
 - (c) At the beginning of the test, all protection devices which affect the function of the Tested-Device and which are relevant to the outcome of the test, shall be operational.

8.2.10.3.2. Test procedure.

The Tested-Device shall be decelerated or accelerated in compliance with the acceleration corridors which are specified in Figure 29 and Tables 7 or 8. The manufacturer shall decide whether the tests shall be conducted in either the positive or negative direction or both.

For each of the test pulses specified, a separate Tested-Device may be used.

The test pulse shall be within the minimum and maximum value as specified in Tables 7 or 8. A higher shock level and /or longer duration as described in the maximum value in Tables 7 or 8 can be applied to the Tested-Device if recommended by the manufacturer.

The test shall end with an observation period of 1 hour at the ambient temperature conditions of the test environment.

Figure 29

Generic description of test pulses

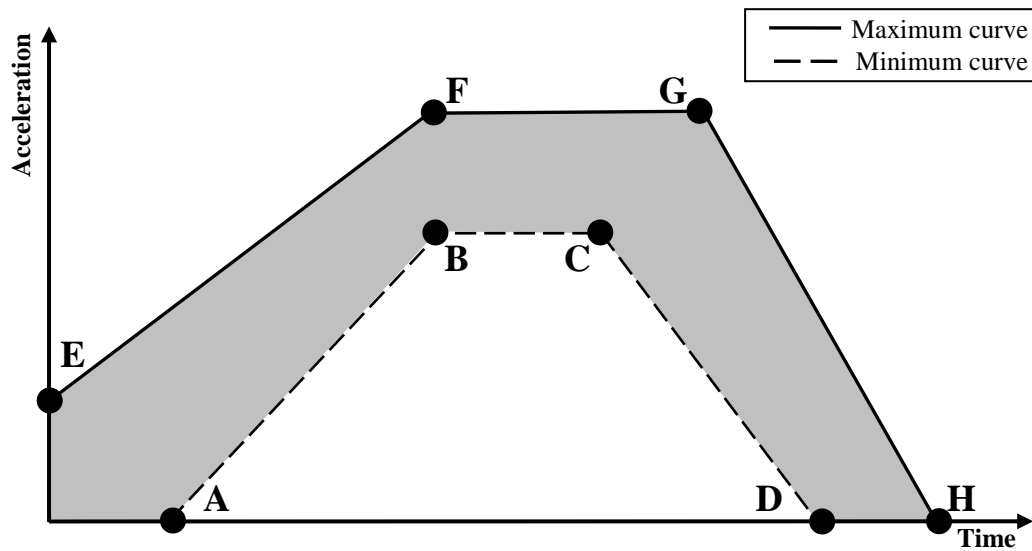

Table 7

Values for vehicles with GVM between 3,500 kg and 12,000 kg

Point	Time (ms)	Acceleration (g)	
		Longitudinal	Transverse
A	20	0	0
B	50	10	5
C	65	10	5
D	100	0	0
E	0	5	2.5
F	50	17	10
G	80	17	10
H	120	0	0

Table 8
Values for vehicles with GVM exceeding 12,000 kg

<i>Point</i>	<i>Time (ms)</i>	<i>Acceleration (g)</i>	
		Longitudinal	Transverse
A	20	0	0
B	50	6.6	5
C	65	6.6	5
D	100	0	0
E	0	4	2.5
F	50	12	10
G	80	12	10
H	120	0	0

Annex 1

Determination of hydrogen emissions during the charge procedures of the REESS

1. Introduction
This annex describes the procedure for the determination of hydrogen emissions during the charge procedures of the REESS with open-type traction battery, according to paragraph 5.4.11.2. of this UN GTR.
2. Description of test
The hydrogen emission test (Figure 1 of this annex) is conducted in order to determine hydrogen emissions during the charge procedures of the REESS with the charger. The test consists in the following steps:
 - (a) Vehicle/REESS preparation;
 - (b) Discharge of the REESS;
 - (c) Determination of hydrogen emissions during a normal charge;
 - (d) Determination of hydrogen emissions during a charge carried out with the charger failure.
3. Tests
 - 3.1. Vehicle based test.
 - 3.1.1. The vehicle shall be in good mechanical condition and have been driven at least 300 km during seven days before the test. The vehicle shall be equipped with the REESS subject to the test of hydrogen emissions, over this period.
 - 3.1.2. If the REESS is used at a temperature above the ambient temperature, the operator shall follow the manufacturer's procedure in order to keep the REESS temperature in normal functioning range.

The manufacturer's representative shall be able to certify that the temperature conditioning system of the REESS is neither damaged nor presenting a capacity defect.
 - 3.2. Component based test.
 - 3.2.1. The REESS shall be in good mechanical condition and have been subject to minimum of 5 standard cycles (as specified in paragraph 6.2.1.1. or paragraph 8.2.1.1, as applicable, of this regulation).
 - 3.2.2. If the REESS is used at a temperature above the ambient temperature, the operator shall follow the manufacturer's procedure in order to keep the REESS temperature in its normal functioning range.

The manufacturer's representative shall be able to certify that the temperature conditioning system of the REESS is neither damaged nor presenting a capacity defect.

Figure 1
Determination of hydrogen emissions during the charge procedures of the REESS

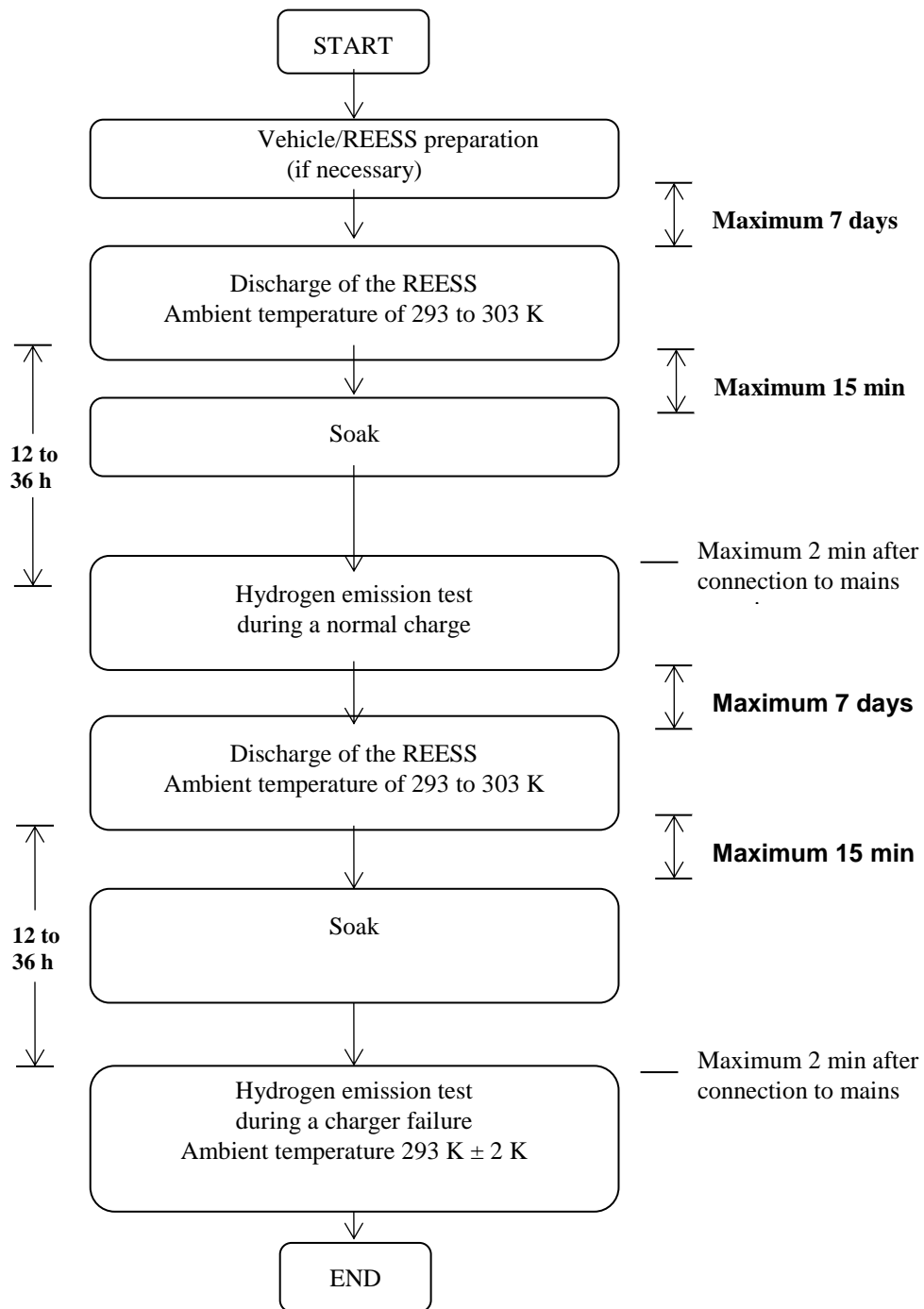

4. Test equipment for hydrogen emission test

4.1. Hydrogen emission measurement enclosure.

The hydrogen emission measurement enclosure shall be a gas-tight measuring chamber able to contain the vehicle/REESS under test. The vehicle/REESS shall be accessible from all sides and the enclosure when sealed shall be gas-tight in accordance with Appendix 1 to this annex. The inner surface of the enclosure shall be impermeable and non-reactive to hydrogen. The temperature conditioning system shall be capable of controlling the internal enclosure air temperature to follow the prescribed temperature throughout the test, with an average tolerance of ± 2 K over the duration of the test.

To accommodate the volume changes due to enclosure hydrogen emissions, either a variable-volume or another test equipment may be used. The variable-volume enclosure expands and contracts in response to the hydrogen emissions in the enclosure. Two potential means of accommodating the internal volume changes are movable panels, or a bellows design, in which impermeable bags inside the enclosure expand and contract in response to internal pressure changes by exchanging air from outside the enclosure. Any design for volume accommodation shall maintain the integrity of the enclosure as specified in Appendix 1 to this annex.

Any method of volume accommodation shall limit the differential between the enclosure internal pressure and the barometric pressure to a maximum value of ± 5 hPa.

The enclosure shall be capable of latching to a fixed volume. A variable volume enclosure shall be capable of accommodating a change from its "nominal volume" (see Annex 1, Appendix 1, paragraph 2.1.1.), taking into account hydrogen emissions during testing.

4.2. Analytical systems.

4.2.1. Hydrogen analyser.

4.2.1.1. The atmosphere within the chamber is monitored using a hydrogen analyser (electrochemical detector type) or a chromatograph with thermal conductivity detection. Sample gas shall be drawn from the mid-point of one side-wall or roof of the chamber and any bypass flow shall be returned to the enclosure, preferably to a point immediately downstream of the mixing fan.

4.2.1.2. The hydrogen analyser shall have a response time to 90 per cent of final reading of less than 10 s. Its stability shall be better than 2 per cent of full scale at zero and at 80 ± 20 per cent of full scale, over a 15-minutes period for all operational ranges.

4.2.1.3. The repeatability of the analyser expressed as one standard deviation shall be better than 1 per cent of full scale, at zero and at 80 ± 20 per cent of full scale on all ranges used.

4.2.1.4. The operational ranges of the analyser shall be chosen to give best resolution over the measurement, calibration and leak checking procedures.

4.2.2. Hydrogen analyser data recording system.

The hydrogen analyser shall be fitted with a device to record electrical signal output, at a frequency of at least once per minute. The recording system shall have operating characteristics at least equivalent to the signal being recorded

and shall provide a permanent record of results. The recording shall show a clear indication of the beginning and end of the normal charge test and charging failure operation.

- 4.3. Temperature recording.
 - 4.3.1. The temperature in the chamber is recorded at two points by temperature sensors, which are connected so as to show a mean value. The measuring points are extended approximately 0.1 m into the enclosure from the vertical centre line of each side-wall at a height of 0.9 ± 0.2 m.
 - 4.3.2. The temperatures in the proximity of the cells are recorded by means of the sensors.
 - 4.3.3. Temperatures shall, throughout the hydrogen emission measurements, be recorded at a frequency of at least once per minute.
 - 4.3.4. The accuracy of the temperature recording system shall be within ± 1.0 K and the temperature shall be capable of being resolved to ± 0.1 K.
 - 4.3.5. The recording or data processing system shall be capable of resolving time to ± 15 s.
- 4.4. Pressure recording.
 - 4.4.1. The difference Δp between barometric pressure within the test area and the enclosure internal pressure shall, throughout the hydrogen emission measurements, be recorded at a frequency of at least once per minute.
 - 4.4.2. The accuracy of the pressure recording system shall be within ± 2 hPa and the pressure shall be capable of being resolved to ± 0.2 hPa.
 - 4.4.3. The recording or data processing system shall be capable of resolving time to ± 15 s.
- 4.5. Voltage and current intensity recording.
 - 4.5.1. The charger voltage and current intensity (battery) shall, throughout the hydrogen emission measurements, be recorded at a frequency of at least once per minute.
 - 4.5.2. The accuracy of the voltage recording system shall be within ± 1 V and the voltage shall be capable of being resolved to ± 0.1 V.
 - 4.5.3. The accuracy of the current intensity recording system shall be within ± 0.5 A and the current intensity shall be capable of being resolved to ± 0.05 A.
 - 4.5.4. The recording or data processing system shall be capable of resolving time to ± 15 s.
- 4.6. Fans.

The chamber shall be equipped with one or more fans or blowers with a possible flow of 0.1 to 0.5 m³/second in order to thoroughly mix the atmosphere in the enclosure. It shall be possible to reach a homogeneous temperature and hydrogen concentration in the chamber during measurements. The vehicle in the enclosure shall not be subjected to a direct stream of air from the fans or blowers.

- 4.7. Gases.
- 4.7.1. The following pure gases shall be available for calibration and operation:
- (a) Purified synthetic air (purity < 1 ppm C₁ equivalent; < 1 ppm CO; < 400 ppm CO₂; < 0.1 ppm NO); oxygen content between 18 and 21 per cent by volume;
 - (b) Hydrogen (H₂), 99.5 per cent minimum purity.
- 4.7.2. Calibration and span gases shall contain mixtures of hydrogen (H₂) and purified synthetic air. The real concentrations of a calibration gas shall be within ± 2 per cent of the nominal values. The accuracy of the diluted gases obtained when using a gas divider shall be within ± 2 per cent of the nominal value. The concentrations specified in Appendix 1 may also be obtained by a gas divider using synthetic air as the dilution gas.
5. Test procedure.
- The test consists in the five following steps:
- (a) vehicle/REESS preparation;
 - (b) discharge of the REESS;
 - (c) determination of hydrogen emissions during a normal charge;
 - (d) discharge of the traction battery;
 - (e) determination of hydrogen emissions during a charge carried out with the charger failure.
- If the vehicle/REESS has to be moved between two steps, it shall be pushed to the following test area.
- 5.1. Vehicle based test.
- 5.1.1. Vehicle preparation.
- The ageing of REESS shall be checked, proving that the vehicle has performed at least 300 km during seven days before the test. During this period, the vehicle shall be equipped with the traction battery submitted to the hydrogen emission test. If this cannot be demonstrated then the following procedure will be applied.
- 5.1.1.1. Discharges and initial charges of the REESS.
- The procedure starts with the discharge of the REESS of the vehicle while driving on the test track or on a chassis dynamometer at a steady speed of 70 ± 5 per cent of the maximum speed of the vehicle during 30 minutes.
- Discharging is stopped:
- (a) When the vehicle is not able to run at 65 per cent of the maximum thirty minutes speed, or
 - (b) When an indication to stop the vehicle is given to the driver by the standard on-board instrumentation, or
 - (c) After having covered the distance of 100 km.

- 5.1.1.2. Initial charge of the REESS.
The charge is carried out:
(a) With the charger;
(b) In an ambient temperature between 293 K and 303 K.
The procedure excludes all types of external chargers.
The end of REESS charge criteria corresponds to an automatic stop given by the charger.
This procedure includes all types of special charges that could be automatically or manually initiated like, for instance, the equalisation charges or the servicing charges.
- 5.1.1.3. Procedure from paragraphs 5.1.1.1. and 5.1.1.2. shall be repeated 2 times.
- 5.1.2. Discharge of the REESS.
The REESS is discharged while driving on the test track or on a chassis dynamometer at a steady speed of 70 ± 5 per cent from the maximum thirty minutes speed of the vehicle.
Stopping the discharge occurs:
(a) When an indication to stop the vehicle is given to the driver by the standard on-board instrumentation, or
(b) When the maximum speed of the vehicle is lower than 20 km/h.
- 5.1.3. Soak.
Within fifteen minutes of completing the battery discharge operation specified in paragraph 5.2., the vehicle is parked in the soak area. The vehicle is parked for a minimum of 12 hours and a maximum of 36 hours, between the end of the traction battery discharge and the start of the hydrogen emission test during a normal charge. For this period, the vehicle shall be soaked at 293 ± 2 K.
- 5.1.4. Hydrogen emission test during a normal charge.
- 5.1.4.1. Before the completion of the soak period, the measuring chamber shall be purged for several minutes until a stable hydrogen background is obtained. The enclosure mixing fan(s) shall also be turned on at this time.
- 5.1.4.2. The hydrogen analyser shall be zeroed and spanned immediately prior to the test.
- 5.1.4.3. At the end of the soak, the test vehicle, with the engine shut off and the test vehicle windows and luggage compartment opened shall be moved into the measuring chamber.
- 5.1.4.4. The vehicle shall be connected to the mains. The REESS is charged according to normal charge procedure as specified in paragraph 5.1.4.7. below.
- 5.1.4.5. The enclosure doors are closed and sealed gas-tight within 2 minutes from electrical interlock of the normal charge step.
- 5.1.4.6. The start of a normal charge for hydrogen emission test period begins when the chamber is sealed. The hydrogen concentration, temperature and

barometric pressure are measured to give the initial readings C_{H2i} , T_i and P_i for the normal charge test.

These figures are used in the hydrogen emission calculation (paragraph 6. of this annex). The ambient enclosure temperature T shall not be less than 291 K and no more than 295 K during the normal charge period.

5.1.4.7. Procedure of normal charge.

The normal charge is carried out with the charger and consists of the following steps:

- (a) Charging at constant power during t_1 ;
- (b) Over-charging at constant current during t_2 . Over-charging intensity is specified by manufacturer and corresponds to the one used during equalisation charging.

The end of REESS charge criteria corresponds to an automatic stop given by the charger to a charging time of $t_1 + t_2$. This charging time will be limited to $t_1 + 5$ h, even if a clear indication is given to the driver by the standard instrumentation that the battery is not yet fully charged.

5.1.4.8. The hydrogen analyser shall be zeroed and spanned immediately before the end of the test.

5.1.4.9. The end of the emission sampling period occurs $t_1 + t_2$ or $t_1 + 5$ h after the beginning of the initial sampling, as specified in paragraph 5.1.4.6. of this annex. The different times elapsed are recorded. The hydrogen concentration, temperature and barometric pressure are measured to give the final readings C_{H2f} , T_f and P_f for the normal charge test, used for the calculation in paragraph 6. of this annex.

5.1.5. Hydrogen emission test with the charger failure.

5.1.5.1. Within seven days maximum after having completed the prior test, the procedure starts with the discharge of the REESS of the vehicle according to paragraph 5.1.2. of this annex.

5.1.5.2. The steps of the procedure in paragraph 5.1.3. of this annex shall be repeated.

5.1.5.3. Before the completion of the soak period, the measuring chamber shall be purged for several minutes until a stable hydrogen background is obtained. The enclosure mixing fan(s) shall also be turned on at this time.

5.1.5.4. The hydrogen analyser shall be zeroed and spanned immediately prior to the test.

5.1.5.5. At the end of the soak, the test vehicle, with the engine shut off and the test vehicle windows and luggage compartment opened shall be moved into the measuring chamber.

5.1.5.6. The vehicle shall be connected to the mains. The REESS is charged according to failure charge procedure as specified in paragraph 5.1.5.9. below.

5.1.5.7. The enclosure doors are closed and sealed gas-tight within 2 minutes from electrical interlock of the failure charge step.

5.1.5.8. The start of a failure charge for hydrogen emission test period begins when the chamber is sealed. The hydrogen concentration, temperature and

barometric pressure are measured to give the initial readings C_{H_2i} , T_i and P_i for the failure charge test.

These figures are used in the hydrogen emission calculation (paragraph 6. of this annex). The ambient enclosure temperature T shall not be less than 291 K and no more than 295 K during the charging failure period.

5.1.5.9. Procedure of charging failure.

The charging failure is carried out with the suitable charger and consists of the following steps:

- (a) Charging at constant power during t'_1 ;
- (b) Charging at maximum current as recommended by the manufacturer during 30 minutes. During this phase, the charger shall supply maximum current as recommended by the manufacturer.

5.1.5.10. The hydrogen analyser shall be zeroed and spanned immediately before the end of the test.

5.1.5.11. The end of test period occurs $t'_1 + 30$ minutes after the beginning of the initial sampling, as specified in paragraph 5.1.5.8. above. The times elapsed are recorded. The hydrogen concentration, temperature and barometric pressure are measured to give the final readings C_{H_2f} , T_f and P_f for the charging failure test, used for the calculation in paragraph 6. of this annex.

5.2. Component based test.

5.2.1. REESS preparation.

The ageing of REESS shall be checked, to confirm that the REESS has performed at least 5 standard cycles (as specified in paragraph 6.2.1.).

5.2.2. Discharge of the REESS.

The REESS is discharged at 70 ± 5 per cent of the nominal power of the system.

Stopping the discharge occurs when minimum SOC as specified by the manufacturer is reached.

5.2.3. Soak.

Within 15 minutes of the end of the REESS discharge operation specified in paragraph 5.2.2. above, and before the start of the hydrogen emission test, the REESS shall be soaked at 293 ± 2 K for a minimum period of 12 hours and a maximum of period of 36 h.

5.2.4. Hydrogen emission test during a normal charge

5.2.4.1. Before the completion of the REESS's soak period, the measuring chamber shall be purged for several minutes until a stable hydrogen background is obtained. The enclosure mixing fan(s) shall also be turned on at this time.

5.2.4.2. The hydrogen analyser shall be zeroed and spanned immediately prior to the test.

5.2.4.3. At the end of the soak period, the REESS shall be moved into the measuring chamber.

5.2.4.4. The REESS shall be charged in accordance with the normal charge procedure as specified in paragraph 5.2.4.7. below.

- 5.2.4.5. The chamber shall be closed and sealed gas-tight within two minutes of the electrical interlock of the normal charge step.
- 5.2.4.6. The start of a normal charge for hydrogen emission test period shall begin when the chamber is sealed. The hydrogen concentration, temperature and barometric pressure are measured to give the initial readings C_{H2i} , T_i and P_i for the normal charge test.
- These figures are used in the hydrogen emission calculation (paragraph 6. of this annex). The ambient enclosure temperature T shall not be less than 291 K and no more than 295 K during the normal charge period.
- 5.2.4.7. Procedure of normal charge
- The normal charge is carried out with a suitable charger and consists of the following steps:
- (a) Charging at constant power during t_1 ;
 - (b) Over-charging at constant current during t_2 . Over-charging intensity is specified by manufacturer and corresponding to that used during equalisation charging.
- The end of REESS charge criteria corresponds to an automatic stop given by the charger to a charging time of $t_1 + t_2$. This charging time will be limited to $t_1 + 5$ h, even if a clear indication is given by a suitable instrumentation that the REESS is not yet fully charged.
- 5.2.4.8. The hydrogen analyser shall be zeroed and spanned immediately before the end of the test.
- 5.2.4.9. The end of the emission sampling period occurs $t_1 + t_2$ or $t_1 + 5$ h after the beginning of the initial sampling, as specified in paragraph 5.2.4.6. above. The different times elapsed are recorded. The hydrogen concentration, temperature and barometric pressure are measured to give the final readings C_{H2f} , T_f and P_f for the normal charge test, used for the calculation in paragraph 6. of this annex.
- 5.2.5. Hydrogen emission test with the charger failure.
- 5.2.5.1. The test procedure shall start within a maximum of seven days after having completed the test in paragraph 5.2.4. above, the procedure shall start with the discharge of the REESS of the vehicle in accordance with paragraph 5.2.2. above.
- 5.2.5.2. The steps of the procedure in paragraph 5.2.3. above shall be repeated.
- 5.2.5.3. Before the completion of the soak period, the measuring chamber shall be purged for several minutes until a stable hydrogen background is obtained. The enclosure mixing fan(s) shall also be turned on at this time.
- 5.2.5.4. The hydrogen analyser shall be zeroed and spanned immediately prior to the test.
- 5.2.5.5. At the end of the soak the REESS shall be moved into the measuring chamber.
- 5.2.5.6. The REESS shall be charged according to the failure charge procedure as specified in paragraph 5.2.5.9. below.
- 5.2.5.7. The chamber shall be closed and sealed gas-tight within 2 minutes from electrical interlock of the failure charge step.

- 5.2.5.8. The start of a failure charge for hydrogen emission test period begins when the chamber is sealed. The hydrogen concentration, temperature and barometric pressure are measured to give the initial readings C_{H2i} , T_i and P_i for the failure charge test.

These figures are used in the hydrogen emission calculation (paragraph 6. of this annex). The ambient enclosure temperature T shall not be less than 291 K and no more than 295 K during the charging failure period.

- 5.2.5.9. Procedure of charging failure.

The charging failure is carried out with a suitable charger and consists of the following steps:

- (a) Charging at constant power during t'_1 ;
- (b) Charging at maximum current as recommended by the manufacturer during 30 minutes. During this phase, the charger shall supply maximum current as recommended by the manufacturer.

- 5.2.5.10. The hydrogen analyser shall be zeroed and spanned immediately before the end of the test.

- 5.2.5.11. The end of test period occurs $t'_1 + 30$ minutes after the beginning of the initial sampling, as specified in paragraph 5.2.5.8. above. The times elapsed are recorded. The hydrogen concentration, temperature and barometric pressure are measured to give the final readings C_{H2f} , T_f and P_f for the charging failure test, used for the calculation in paragraph 6. below.

6. Calculation

The hydrogen emission tests described in paragraph 5. above allow the calculation of the hydrogen emissions from the normal charge and charging failure phases. Hydrogen emissions from each of these phases are calculated using the initial and final hydrogen concentrations, temperatures and pressures in the enclosure, together with the net enclosure volume.

The formula below is used:

$$M_{H2} = k \times V \times 10^{-4} \times \left(\frac{(1 + \frac{V_{out}}{V}) \times C_{H2f} \times P_f}{T_f} - \frac{C_{H2i} \times P_i}{T_i} \right)$$

Where:

M_{H2} = hydrogen mass, in grams;

C_{H2} = measured hydrogen concentration in the enclosure, in ppm volume;

V = net enclosure volume in cubic metres (m^3) corrected for the volume of the vehicle, with the windows and the luggage compartment open. If the volume of the vehicle is not determined a volume of 1.42 m^3 is subtracted;

V_{out} = compensation volume in m^3 , at the test temperature and pressure;

T = ambient chamber temperature, in K;

P = absolute enclosure pressure, in kPa;

$$K = 2.42;$$

Where: i is the initial reading;

f is the final reading.

6.1. Results of test.

The hydrogen mass emissions for the REESS are:

M_N = hydrogen mass emission for normal charge test, in g;

M_D = hydrogen mass emission for charging failure test, in g.

Annex 1 - Appendix 1

Calibration of equipment for hydrogen emission testing

1. Calibration frequency and methods

All equipment shall be calibrated before its initial use and then calibrated as often as necessary and in any case in the month before type approval testing. The calibration methods to be used are described in this appendix.
2. Calibration of the enclosure
 - 2.1. Initial determination of enclosure internal volume.
 - 2.1.1. Before its initial use, the internal volume of the chamber shall be determined as follows. The internal dimensions of the chamber are carefully measured, taking into account any irregularities such as bracing struts. The internal volume of the chamber is determined from these measurements.

The enclosure shall be latched to a fixed volume when the enclosure is held at an ambient temperature of 293 K. This nominal volume shall be repeatable within ± 0.5 per cent of the reported value.
 - 2.1.2. The net internal volume is determined by subtracting 1.42 m³ from the internal volume of the chamber. Alternatively the volume of the test vehicle with the luggage compartment and windows open or REESS may be used instead of the 1.42 m³.
 - 2.1.3. The chamber shall be checked as in paragraph 2.3. of this annex. If the hydrogen mass does not agree with the injected mass to within ± 2 per cent then corrective action is required.
 - 2.2. Determination of chamber background emissions.

This operation determines that the chamber does not contain any materials that emit significant amounts of hydrogen. The check shall be carried out at the enclosure's introduction to service, after any operations in the enclosure which may affect background emissions and at a frequency of at least once per year.

 - 2.2.1. Variable-volume enclosure may be operated in either latched or unlatched volume configuration, as described in paragraph 2.1.1. above. Ambient temperature shall be maintained at 293 ± 2 K, throughout the 4-hours period mentioned below.
 - 2.2.2. The enclosure may be sealed and the mixing fan operated for a period of up to 12 h before the 4-hours background-sampling period begins.
 - 2.2.3. The analyser (if required) shall be calibrated, then zeroed and spanned.
 - 2.2.4. The enclosure shall be purged until a stable hydrogen reading is obtained, and the mixing fan turned on if not already on.
 - 2.2.5. The chamber is then sealed and the background hydrogen concentration, temperature and barometric pressure are measured. These are the initial readings C_{H_2i} , T_i and P_i used in the enclosure background calculation.
 - 2.2.6. The enclosure is allowed to stand undisturbed with the mixing fan on for a period of 4 hours.

- 2.2.7. At the end of this time the same analyser is used to measure the hydrogen concentration in the chamber. The temperature and the barometric pressure are also measured. These are the final readings C_{H_2f} , T_f and P_f .
- 2.2.8. The change in mass of hydrogen in the enclosure shall be calculated over the time of the test in accordance with paragraph 2.4. of this annex and shall not exceed 0.5 g.
- 2.3. Calibration and hydrogen retention test of the chamber
- The calibration and hydrogen retention test in the chamber provides a check on the calculated volume (paragraph 2.1. above) and also measures any leak rate. The enclosure leak rate shall be determined at the enclosure's introduction to service, after any operations in the enclosure which may affect the integrity of the enclosure, and at least monthly thereafter. If 6 consecutive monthly retention checks are successfully completed without corrective action, the enclosure leak rate may be determined quarterly thereafter as long as no corrective action is required.
- 2.3.1. The enclosure shall be purged until a stable hydrogen concentration is reached. The mixing fan is turned on, if not already switched on. The hydrogen analyser is zeroed, calibrated if required, and spanned.
- 2.3.2. The enclosure shall be latched to the nominal volume position.
- 2.3.3. The ambient temperature control system is then turned on (if not already on) and adjusted for an initial temperature of 293 K.
- 2.3.4. When the enclosure temperature stabilizes at $293\text{ K} \pm 2\text{ K}$, the enclosure is sealed and the background concentration, temperature and barometric pressure measured. These are the initial readings C_{H_2i} , T_i and P_i used in the enclosure calibration.
- 2.3.5. The enclosure shall be unlatched from the nominal volume.
- 2.3.6. A quantity of approximately 100 g of hydrogen is injected into the enclosure. This mass of hydrogen shall be measured to an accuracy of ± 2 per cent of the measured value.
- 2.3.7. The contents of the chamber shall be allowed to mix for five minutes and then the hydrogen concentration, temperature and barometric pressure are measured. These are the final readings C_{H_2f} , T_f and P_f for the calibration of the enclosure as well as the initial readings C_{H_2i} , T_i and P_i for the retention check.
- 2.3.8. On the basis of the readings taken in paragraphs 2.3.4 and 2.3.7 above and the formula in paragraph 2.4. below, the mass of hydrogen in the enclosure is calculated. This shall be within ± 2 per cent of the mass of hydrogen measured in paragraph 2.3.6. above.
- 2.3.9. The contents of the chamber shall be allowed to mix for a minimum of 10 hours. At the completion of the period, the final hydrogen concentration, temperature and barometric pressure are measured and recorded. These are the final readings C_{H_2f} , T_f and P_f for the hydrogen retention check.
- 2.3.10. Using the formula in paragraph 2.4. below, the hydrogen mass is then calculated from the readings taken in paragraphs 2.3.7 and 2.3.9. above. This mass may not differ by more than 5 per cent from the hydrogen mass given by paragraph 2.3.8. above.

2.4. Calculation.

The calculation of net hydrogen mass change within the enclosure is used to determine the chamber's hydrocarbon background and leak rate. Initial and final readings of hydrogen concentration, temperature and barometric pressure are used in the following formula to calculate the mass change.

$$M_{H_2} = k \times V \times 10^{-4} \times \left(\frac{\left(1 + \frac{V_{out}}{V}\right) \times C_{H_2f} \times P_f}{T_f} - \frac{C_{H_2i} \times P_i}{T_i} \right)$$

Where:

- M_{H_2} = hydrogen mass, in grams
- C_{H_2} = measured hydrogen concentration into the enclosure, in ppm volume
- V = enclosure volume in cubic metres (m³) as measured in paragraph 2.1.1. above.
- V_{out} = compensation volume in m³, at the test temperature and pressure
- T = ambient chamber temperature, in K
- P = absolute enclosure pressure, in kPa
- k = 2.42

Where: i is the initial reading

f is the final reading

3. Calibration of the hydrogen analyser

The analyser should be calibrated using hydrogen in air and purified synthetic air. See paragraph 4.8.2. of Annex 1.

Each of the normally used operating ranges is calibrated by the following procedure:

- 3.1. Establish the calibration curve by at least five calibration points spaced as evenly as possible over the operating range. The nominal concentration of the calibration gas with the highest concentrations to be at least 80 per cent of the full scale.
- 3.2. Calculate the calibration curve by the method of least squares. If the resulting polynomial degree is greater than 3, then the number of calibration points shall be at least the number of the polynomial degree plus 2.
- 3.3. The calibration curve shall not differ by more than 2 per cent from the nominal value of each calibration gas.
- 3.4. Using the coefficients of the polynomial derived from paragraph 3.2. above, a table of analyser readings against true concentrations shall be drawn by steps no greater than 1 per cent of full scale. This is to be carried out for each analyser range calibrated.

This table shall also contain other relevant data such as:

- (a) date of calibration;

- (b) span and zero potentiometer readings (where applicable);
 - (c) nominal scale;
 - (d) reference data of each calibration gas used;
 - (e) real and indicated value of each calibration gas used together with the percentage differences;
 - (f) calibration pressure of analyser.
- 3.5. Alternative methods (e.g. computer, electronically controlled range switch) can be used if it is proven to the technical service that these methods give equivalent accuracy.

Annex 2

Verification method for testing authorities confirming document based isolation resistance compliance of electrical design of the vehicle after water exposure

This annex describes the applicable requirements when certifying the manufacturers' high voltage equipment or system components against adverse water effects rather than a physical test. As a general rule, the electrical design or components of the vehicles shall comply with the requirements as specified in paragraphs "5.1.1.1. or 7.1.1.1. Protection against direct contact, 5.1.1.2. or 7.1.1.2. Protection against indirect contact", and 5.1.1.2.4. or 7.1.1.2.4. respectively. Isolation resistance and this will be separately verified by the testing authority. Vehicle manufacturers shall provide information to testing authorities to identify, as a point of reference, the mounting location for each high-voltage component in/on the vehicle.

1. Documentation shall contain the following information:
 - (a) on how the manufacturer tested isolation resistance compliance of electrical design of the vehicle by using fresh water;
 - (b) on how, after the test had been carried out, the high-voltage component or system was inspected for ingress of water and how, depending on its mounting location, each high voltage component/system met the appropriate degree of protection against water.
2. The testing authority will verify and confirm the authenticity of documented conditions that have been observed, and should have been complied with, during the process of certification by manufacturer:
 - 2.1. It is permitted that, during the test, the moisture contained inside the enclosure is partly condensed. The dew which may be deposited is not considered as ingress of water. For the purpose of the tests, the surface area of the tested high-voltage component or system is calculated with an accuracy of 10 per cent. If possible, the tested high-voltage component or system is run energized. If the tested high-voltage component or system is energized, adequate safety precautions are taken.
 - 2.2. For electrical components, externally attached (e.g. in engine compartment), open underneath, both exposed or protected locations, the testing authority shall verify, with a view to confirming the compliance, whether the test is conducted by spraying the high-voltage component or system from all practicable directions with a stream of water from a standard test nozzle as shown in Figure 1. The following parameters are observed during the test in particular:
 - (a) Nozzle internal diameter: 6.3 mm;
 - (b) Delivery rate: 11.9 – 13.2 l/min;
 - (c) Water pressure at the nozzle: approximately 30 kPa (0.3 bar);
 - (d) Test duration per m² of surface area of the tested high-voltage component or system: 1 min;

- (e) Minimum test duration: 3 min;
- (f) Distance from nozzle to tested high-voltage component or system surface: approximately 3 m (this distance may be reduced, if necessary to ensure proper wetting when spraying upwards).

Figure 1
Standard nozzle for the test

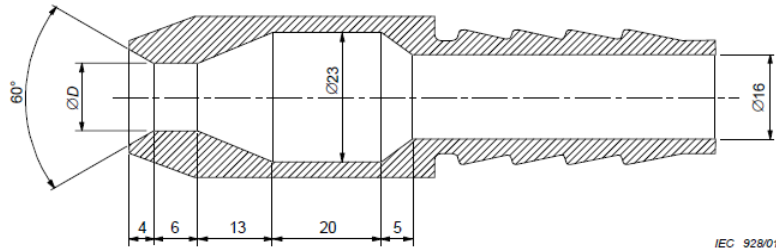

Dimensions in millimetres
 D is 6.3 mm as specified in (a) above.

- 2.3. For electrical components, externally attached (e.g. in engine compartment), covered from underneath, the testing authority shall verify, with a view to confirming the compliance, whether:
- (a) The cover protects the component against direct spray water from underneath and is not visible;
 - (b) The test is conducted by using splashing test nozzle as shown in Figure 2;
 - (c) The moving shield is removed from the spray nozzle and the machine is sprayed from all practicable directions;
 - (d) The water pressure is adjusted to give a delivery rate of (10 ± 0.5) l/min (pressure approximately 80 kPa to 100 kPa (0.8 bar to 1.0 bar));
 - (e) The test duration is 1 min/m^2 of calculated surface area of the machine (excluding any mounting surface and cooling fin) with a minimum duration of 5 min.

Figure 2
Splashing test nozzle

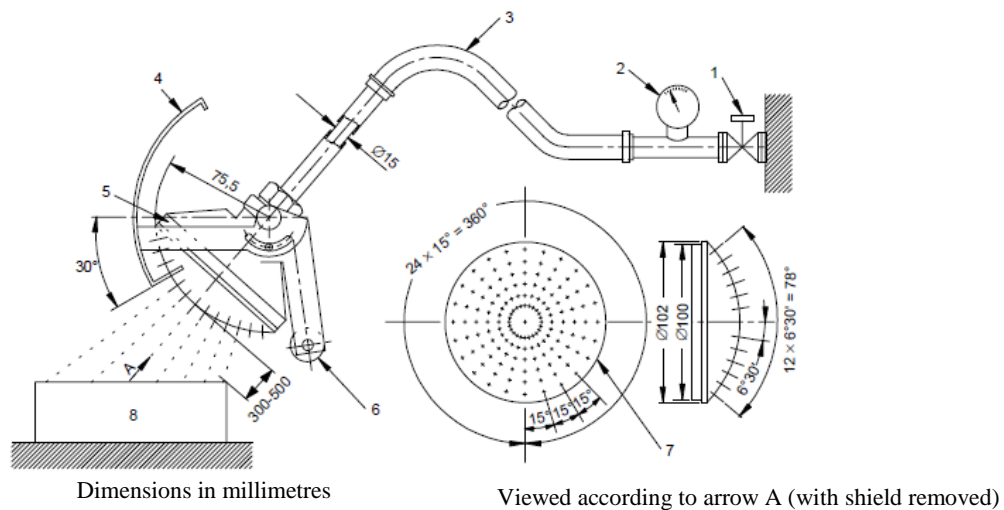

IEC 927/01

Note:

- | | |
|--|--|
| <p>1. Cock</p> <p>2. Pressure gauge</p> <p>3. Hose</p> <p>4. Moving shield – aluminium</p> <p>5. Spray nozzle</p> <p>6. Counter weight</p> | <p>7. Spray nozzle – brass with 121 holes $\varnothing 0,5$:</p> <p>1 hole in centre</p> <p>2 inner circles of 12 holes at 30° pitch</p> <p>4 outer circles of 24 holes at 15° pitch</p> <p>8. Machine under test</p> |
|--|--|
3. The entire high voltage system or each component is checked to comply with the isolation resistance requirement in paragraph 5.1.1.2.4. or paragraph 7.1.1.2.4. with the following conditions:
 - (a) The electric chassis shall be simulated by an electric conductor, e.g. a metal plate, and the components are attached with their standard mounting devices to it;
 - (b) Cables, where provided, shall be connected to the component.
 4. The parts designed not to be wet during operation are not allowed to be wet and no accumulation of water which could have reached them is tolerated inside the high-voltage component or system.